

S.V. Moskvina, A.A. Khadartsev

Basic Techniques of Low Level Laser Therapy

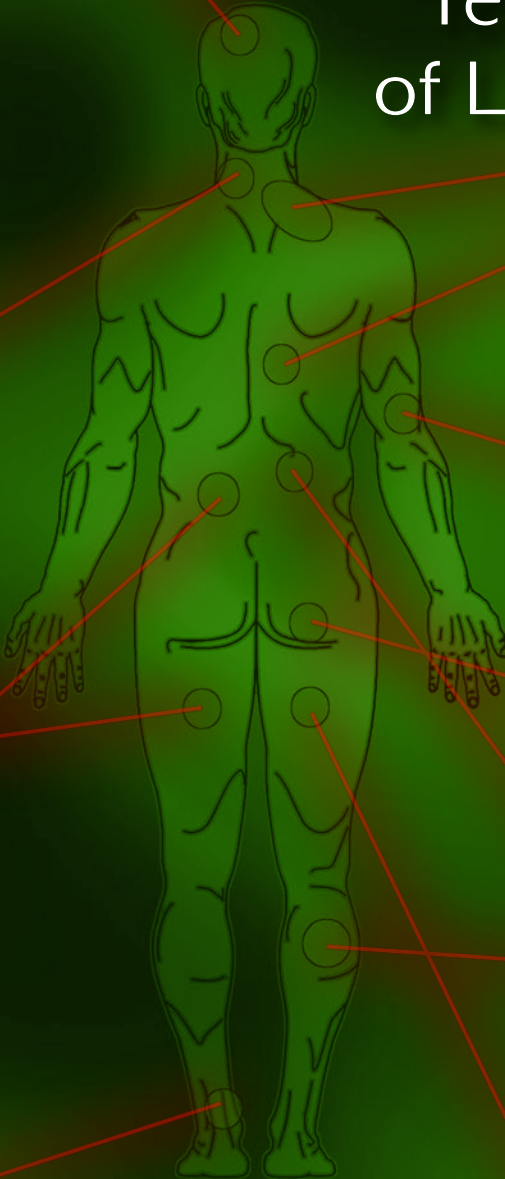

S.V. MOSKVIN, A.A. KHADARTSEV

**BASIC TECHNIQUES
OF LOW LEVEL LASER THERAPY**

MOSCOW–TVER, 2017

УДК 615.849.19
ББК 53.54
M82

M82 **Moskvin S.V., Khadartsev A.A.** Basic Techniques of Low Level Laser Therapy. – M.–Tver: Triada, 2017. – 144 p.
978-5-94789-772-2

The book describes a modern look at the mechanisms of therapeutic action of low-intensity laser illumination, explaining the high efficiency and safety of low level laser therapy. Basic techniques of treatment are presented in a simple and understandable form. For more information about the new techniques and the latest research in this field of science and medicine, please refer to our website <http://lazmik.ru>.

New laser therapeutic devices of the “LASMIK” series with unique laser emitting heads are the most effective when implemented by the majority of techniques presented in the book.

The book is intended for everyone who uses low level laser therapy in their professional practice.

Moskvin Sergey Vladimirovich – Doctor of Biological Sciences, Candidate of Engineering Sciences, Leading Researcher of FSBI “State Scientific Center of Laser Medicine of FMBA of Russia”, Moscow; e-mail: 7652612@mail.ru, www.lazmik.ru

Khadartsev Aleksandr Agubechirovich – Doctor of Medicine, Professor, Honoured science worker of the Russian Federation, Director of the medical institute FSBEI of Higher Education “Tula State University”, Tula; 1464 scientific publications, including 93 monographs, 9 inventions, 64 authorship certificates and patents; e-mail: ahadar@yandex.ru, website: <http://khadartsev.ru>

ББК 53.54

ABBREVIATIONS

AOS	– antioxidant system
AP	– acupuncture point
CCBI	– chronic cerebrovascular ischaemia
CCI	– craniocerebral injury
CI	– confidence interval
CIC	– circulating immune complexes
CVI	– chronic venous insufficiency
DEP	– dyscirculatory encephalopathy
DMW	– decimeter waves
EAC-RFC	– EAC-rosette forming cells of erythrocyte (E) – antibody (A) – complement (C) complex;
ED	– energy density
EH	– essential hypertension
NLBI	– non-invasive (external, extravenous, transcutaneous, percutaneous) laser blood illumination
GA	– gonarthrosis (arthrosis of the knee)
HDL	– high density lipoproteins
ILBI	– intravenous laser blood illumination
IR	– infrared (spectrum, band)
LDL	– low density lipoproteins
LLLT	– low level laser therapy
LILI	– low-intensity laser illumination
LPO	– lipid peroxidation
LUVBI®	– laser ultraviolet blood illumination
MAH	– major arteries of the head
MFPS	– myofascial pain syndrome
MLLLT	– magnetic low level laser therapy
MSS	– musculo-skeletal system
OA	– osteoarthritis
OP	– osteoporosis
PD	– power density
PMF	– permanent magnetic field
PsA	– psoriatic arthritis
RA	– rheumatoid arthritis
RCT	– randomized controlled trial
TC	– total cholesterol
TG	– thermography
TPT	– therapeutic physical training
USDG	– ultrasonic Doppler examination
UST	– ultrasound therapy
UV	– ultraviolet (spectrum, band)
UVBI	– ultraviolet blood illumination
VBI	– vertebrobasilar insufficiency
WMD	– weighted mean difference

INTRODUCTION

Laser was used in ancient Rome for coughing, during various infections and intestinal diseases as a stimulator and hypotensive agent. The fruits were also used in preparing a special kind of sausage, meat dishes and compote. This is, of course, referring to grass – *trilobate laserwort* – and its Latin name. We know the word laser (LASER) more commonly as an abbreviation composed of the initial letters of the English phrase: Light Amplification by Stimulated Emission of Radiation. The greatest invention of the 20th century appeared thanks to Russian scientists, laureates of Nobel Prize in Physics, N.G. Basov, A.M. Prokhorov and American C.H. Townes (1964). Later in 2000's, the Nobel Prize was awarded to Z.I. Alferov for the studies that formed the development of diode lasers. It is now impossible to imagine any science and technology industry where lasers are not used.

More than 50 years ago, laser light began to be used as a highly effective therapeutic agent in Russia for the first time. Today, low level laser therapy (LLLT) is developed through the efforts of mostly Russian scientists and doctors, but it is becoming more widespread and recognized in other countries. For several decades, hundreds of treatment techniques and relapse prevention of various diseases in almost all areas of medicine have been developed in Russia. Therefore, it can be said that we have the most effective LLLT techniques and the best equipment in the world – we can be proud of our achievements!

The basis of the therapeutic effect of low-intensity laser illumination (LILI) is a thermodynamic launch of Ca^{2+} -dependent processes. This has allowed us to have a new look, not only at the problem of increasing the effectiveness of low level laser therapy, but also to look at the methodological approaches of the choice of treatment strategies as a whole. Now there is a deep scientific basis, which describes in detail the processes occurring in the absorption of low-intensity laser light, and we were able to develop the technology of low level laser therapy while abiding to a strict compliance with a certain sequence of operations, setting an initial set of parameters that almost certainly guarantee to provide the desired therapeutic effect. This allows professionals to understand how and what characteristics of the technique (wavelength, power and pulse repetition

frequency of LILI, laser operational mode, exposure and localization) should be varied to enhance the effect.

The authors hope that this book will help in daily work, and any questions can be emailed to: 7652612@mail.ru.

GENERAL POINTS OF LOW LEVEL LASER THERAPY

Mechanisms of the Therapeutic Effect of Low Level Laser Therapy

The process of therapeutic effects of low level laser illumination (coherent, monochromatic and polarized light) can be conventionally divided into three main stages:

- 1) primary effects (change of state of the electronic levels of the living matter of molecules, the stereo-chemical rearrangement of molecules, the local thermodynamic shifts and the emergence of an increased concentration of calcium ions in the cytosol);
- 2) secondary effects (propagation of waves of increased Ca^{2+} concentration in the cell, between cells, stimulation or inhibition of biological processes at a cellular level and changes in the functional state of individual biological cell systems and the body as a whole);
- 3) residual after-effects (formation of tissue metabolism products, response of the immune, endocrine and neurohumoral regulation systems, etc.).

All this variety of the developing processes determine the widest range of the body's responses to laser illumination. Fig. 1 shows virtually the entire sequence of events starting from the initial act of photon absorption and finishing with effects at the 'whole body' level. This explains numerous, if not all known phenomena in this field of biology and medicine.

It was previously shown that the initial starting moment of the biological effects of LILI is a local violation of the thermodynamic equilibrium, causing the release of calcium ions from the intracellular store and the propagation of waves with an increased concentration of Ca^{2+} in the cytosol of the cell, triggering Ca^{2+} -dependent processes [Moskvin S., 2016; Moskvin S.V., 2003, 2008, 2014, 2016]. Then secondary effects develop, which are a complex of the non-specific adaptive and compensatory reactions that occur in the tissues, organs and entire living body, among which the following: effects are distinguished most often:

- activation of the cell metabolism and increase in its functional activity,
- stimulation of reparative processes,
- anti-inflammatory effect,

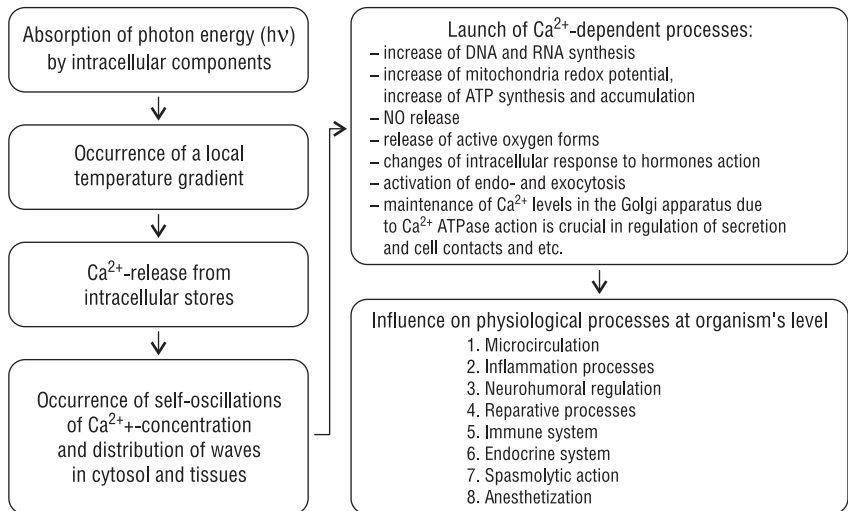

Fig. 1. The sequence of the developing biological effects of laser exposure

- activation of blood microcirculation,
- increase in tissue trophic support,
- analgesic and immunomodulatory effect,
- reflexogenic impact on the functional activity of various organs and systems.

Numerous studies have shown that LILI acts as an activator of cellular responses aimed at restoring and normalizing the bioenergetic status of the body's tissues and immune system. LILI increases enzymatic and catalase activity, permeability of the cytoplasmic membranes, contributing to the acceleration of metabolic and transport processes in tissues. Accelerated oxygen exchange reduces hypoxia accompanying inflammatory processes.

LILI activates the regenerative processes in pathological conditions (trauma, surgical procedures, transplantation) due to changes in the cellular composition in the area of the wound or ulcer by increasing the number of neutrophils, as well as by accelerating the growth of capillaries and accumulating collagen produced by them, which determines the speed and quality of wound or ulcer surface epithelialization. In addition, hormonal and neurotransmitter components of the adaptive mechanism are activated. An increase in non-specific immunity of the body after LILI

exposure is confirmed by the rising titer of hepagglutinin, hemolysins, lysozyme, activation of neutrophils and interferons, increased synthesis of immunoglobulins and changed function and structure of plasma membranes and increase in the number of lymphocyte blast forms.

Laser illumination reduces the concentration of lipid peroxidation products in the blood, enhancing the antioxidant system, increases the level of catalase, activates the cellular elements of mononuclear phagocytes (macrophages) that stimulate cell proliferation and accelerates restoration of morpho-functional state of the cell membranes.

In development of the body response an important role is played by the impact of LILI on the blood, exerting a beneficial complex (systemic) influence caused by common hemocirculation. Studies using vital microscopy, computer capillaroscopy and photographic recording showed an increase in the number of functioning capillaries, acceleration of blood flow and normalization of microcirculation in general. Central hemodynamics are changing as well; it is proved that LILI has venomotor and artery dilation effects in case of initially decreased indicators.

Low level laser therapy, conducted before the start of any surgery intervention in order to prevent infiltration and suppuration, improves local blood circulation, metabolism, oxygenation and maintenance of the trophic support of tissues, which stabilizes the postoperative course, reducing the probability of developing complications by several times.

LILI's ability to increase the content of neurohormones in tissues, to involve various specific proteins of cell membranes in the process which activate enzymes such as adenocyclase, adenylate cyclase, denyl cyclase, phosphodiesterase and calcium ions, altering the intra- and extracellular metabolism, to affect sensitive components of intercellular spaces leads to the normalization of the local and general physiological response, contributes to the preservation or restoration of homeostasis and body adaptation to stress conditions.

Equipment for Low Level Laser Therapy

A variety of techniques and applications of low level laser therapy devices require maximum versatility of the equipment used to ensure maximum efficiency of the therapeutic effects, which, in turn, is ensured by the following procedures:

- (separate) use of LILI with different wavelengths;

- operation in modulated and pulsed modes;
- external illumination modulation (BIO mode, modulation by musical rhythm, etc.);
- illumination delivery with minimal losses through the light guides (ILBI, abdominal procedures); illumination
- optimal spatial distribution of the laser illumination (providing optimum power density);
- reliable and continuous monitoring of the impact parameters.

The proposed modular design concept allows the successful solving of all of these tasks, according to which the laser therapeutic equipment is conventionally divided into four mating parts (Figure 2.): 1 – the base unit (usually 2 – and 4-channel); 2 – laser emitting heads for different low level laser therapy techniques; 3 – optical and magnetic nozzles; 4 – Matrix-Bio biocontrol unit.

The base unit is the basis of each set; it is a power supply and control unit. Its main functions include setting emission modes with mandatory control of the parameters: frequency, session time, beam output power, etc.

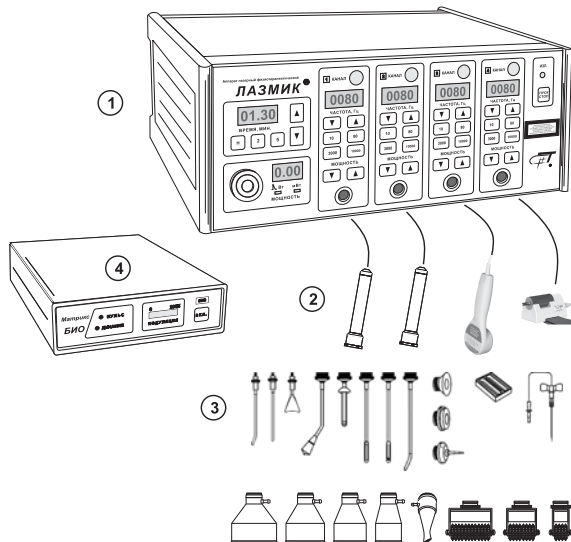

Fig. 2. Modular design concept of low level laser therapy equipment exemplified by a series of Matrix and LASMIK devices

Control of parameters not only insures against errors in selecting the initial values, but also provides the possibility of varying the exposure modes in a wide range, which, in turn, allows professionals to provide optimal treatment options.

Laser emitting heads of various types with the appropriate nozzles (magnetic and optical) are connected to the base unit. In the advanced equipment, a provision is made for the external modulation of beam output power of heads, for example, by the patient's biorhythms.

Laser therapeutic devices of the Matrix and LASMIK series are effective, easy to operate, have a modern design, enabling them to be applied successfully in the best medical centers. In addition, based on these devices, it is possible to create highly efficient specialized complexes, which have already proved themselves as the best. Find more detailed information in a color inset.

The Peculiarities of Applying Various Low Level Laser Therapy Techniques

Low level laser therapy (LLLT) is a physiotherapy method, using electromagnetic illumination in the optical range – coherent light or low level laser illumination (LLLI), generated by special sources. These lasers are a healing factor. The main properties of laser light are the monochromaticity, coherence, polarization and directionality, due to which low level laser therapy, being a kind of physiotherapeutic light exposure, has unique healing properties and methodological features of practical application.

Monochromaticity (Greek *monos* – one, single, the only + *chroma* – color, paint) means illumination in a very narrow range of wavelengths. Illumination within a spectral width of less than 3nm may be taken conventionally as monochromatic. This property offers the opportunity for selective action on the structural components of tissues and cells, triggering an entire cascade of primary biochemical and biophysical processes.

Coherence (Latin *cohaerens* – the state of being connected, related) is a consistent progress of several oscillatory wave processes of the same frequency and polarization in time and/or space.

Polarization is symmetry in the distribution of the orientation of electric and magnetic field vectors relative to the direction of the electromagnetic wave propagation. If two mutually perpendicular components of

the electric field vector oscillate with a time-constant phase difference, this such wave is polarized.

Directionality is an important property of laser illumination, enabling, if necessary, to obtain a higher power density (of incident energy) in comparison to other light sources.

The average capacities of physiotherapeutic lasers are often within the ranges of 1–100mW, pulse power varies from 5 to 100W with a duration of light pulses being 100–130ns ($\sim 10^{-7}$ s). The nature of the primary photobiological reactions is determined by the energy of quanta of optical illumination of less than 2eV on the red and near-infrared spectra; however, it is sufficient to enhance the oscillatory processes of molecules, initiating numerous secondary biophysical and biochemical processes. At present, an increasing number of scientific publications are devoted to the study of the effectiveness of LILI on the ultraviolet and green spectra with higher energy of quanta.

There are many randomized controlled studies (RCS) by a number of researchers that are based on the data that irrefutably proved the diverse medicinal properties of LILI are defined by the following effects [Moskvin S.V., 2014, 2016]:

- microcirculation activation;
- immunomodulatory and anti-inflammatory effect;
- analgesic effect;
- tissue proliferation and regeneration activation;
- diversified action on the nervous tissue, including reflex action.

Low level laser therapy has found widespread application in clinical practice; this method is widely used in almost all fields of modern medicine. There is a large amount of factual material, confirming its high efficacy in the treatment of patients with diseases of the musculo-skeletal, cardiovascular and nervous systems, as well as diseases of the ear, nose and throat, and also in the rehabilitation of patients after injuries and surgery. At the same time there is a discrepancy in the recommended LILI parameters, making it difficult for clinicians to select the most effective technique in terms of evidentiary medicine. Only a deep and comprehensive analysis of RCTs carried out by domestic and foreign researchers with an objective assessment of the results of the low level laser therapy course will help improve the quality of medical services.

Contraindications [Laser therapy...: clinical recommendations. Moscow, 2015]. When ordering LLLT, the following contraindications

should be taken into account: hemorrhagic syndrome, neoplastic syndrome, hyperthermal syndrome (fever, the patient's body temperature above 38 °C), systemic (cardiac, vascular, respiratory, renal and hepatic) decompensation syndrome and multi-organ dysfunction syndrome (the patient's total heavy condition), cachectic syndrome (rapid cachexia), epileptic syndrome, hysterical syndrome, convulsive disorder. Dramatic worsening of synovitis with a high degree of inflammatory activity is a contraindication of LT in patients with arthropathy.

Low Level Laser Therapy Protocols

Fulfilling all the requirements for the implementation of the low level laser therapy protocols is mandatory, since the need to set all the parameters of methods listed below is clearly proved. Even one wrong value will not allow getting a predictable and adequate response to laser light action and the desired therapeutic effect, respectively.

Setting energy parameters substantially depends on the laser operating mode and technique. A majority of Russian devices have a laser hazard Class 1M or 2M according to IEC 60825-1: 2007, while foreign lasers mainly have the laser hazard Class 3R, which greatly complicates their application. Moreover, most cases require minimal energy of LILI to successfully implement low level laser therapy techniques, and increased power and exposure (energy) can result in an inhibitory effect, i.e. complications.

All techniques of low level laser therapy must contain the following information.

1. Laser light wavelength as measured in nanometres [nm] (The International System of Units (SI), 8th edition. – Bureau International des Poids et Mesures, 2006.). The most wide-spread LT spectral ranges are:

- 365–405nm – ultraviolet (UV) spectrum,
- 440–445nm – blue spectrum,
- 520–525nm – green spectrum,
- 635nm – red spectrum,
- 780–785nm – infrared (IR) spectrum,
- 890–904nm – infrared (IR) spectrum.

It is inadmissible to illuminate one and the same area simultaneously with lasers having different wavelengths or incoherent light sources due to inhibiting interference.

2. Laser operational mode: continuous, modulated, pulsed.
3. Beam output power.

The average power of continuous lasers operating in continuous and modulated modes is measured in milliwatts [mW], the impulse (peak) power of pulsed lasers is measured in watts [W].

4. The modulation frequency or pulse repetition frequency for pulse mode is the number of vibrations (pulses) per unit time (second). It is measured in hertz [Hz, 1/s].

5. The most important parameter of pulsed lasers is the duration of the light pulse, it is a constant (most commonly 100–150ns). The average power of pulsed lasers ($P_{av.}$) is directly proportional to the pulsed power (P_p), pulse duration (τ_p) and frequency (F_p): $P_{av.} = P_p \times \tau_p \times F_p$.

6. Illumination area is measured in square centimeters [cm²].

The required area is almost always provided by the procedure without carrying out unnecessary measurements, for example, in contact-mirror method the area is assumed to be 1 cm². In matrix emitters laser diodes must be positioned so that the area of their impact would provide the multiplicity in power density. For example, 8 (most often) pulsed laser diodes having a power of 10W shall be disposed on the surface of 8cm², and in contact with the skin through a transparent tip PD will be 10W/cm², respectively. During laser acupuncture or intravenous laser blood illumination (ILBI) the area is not specified, as the exposed zone is too small, and the leading role is played by scattering and absorption of the laser light energy in the volume of biological tissues.

7. Power density is measured in watts (for pulsed lasers) or milliwatts per square centimeter [W/cm² or mW/cm²].

8. The exposure (the exposure time) per one zone and total time for the procedure are measured in seconds [s] or minutes [min].

9. Localization of action (technique), the exposed zones should be specified.

10. The number of procedures per course and their frequency.

Calculations of energy, which is measured in Joules [J or W·s] or energy density [J/cm² or W·s/cm²] *shall not be carried out*, because this information is not necessary to provide effective low level laser therapy.

It is recommended to include one of the methods of overall impact into the protocol (laser acupuncture or ILBI), and the methods for directly illuminating the affected area by zones (local, transcutaneous or abdominal procedures, as well as the combined method – laser phoresis).

Local LILI is administered directly on the affected area, located close to the surface of the body, either through direct contact through the mirror nozzle or by distance, in a stable manner, at a short distance from the surface (1–2cm), if it is impossible to provide direct contact. Sometimes a combined physiotherapy method – magnetic low level laser therapy (MLLLT) – is used with a laser beam acting through the opening of a permanent magnet, with an induction of 35–50mT (Fig. 3) [Moskvin S.V., 2016].

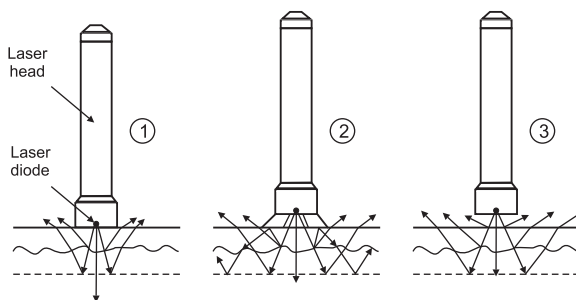

Fig. 3. Contact (1), contact-mirror (2) and distant (3) low level laser therapy techniques

The following procedures are used most often for local laser exposure (tables. 1–3):

- continuous LILI of the red spectrum (635nm), PD – 10–15mW/cm²,
- pulsed LILI of the red spectrum (635nm), PD – 4–5W/cm², pulse duration of 100–150ns, frequency of 80–10,000Hz,
- pulsed IR LILI (890–904nm), PD – 8–10W/cm², pulse duration of 100–150ns, frequency of 80–10,000Hz.

Table 1

Parameters of contact-mirror and distant low level laser therapy techniques

Parameter	Value	Notes
Laser light wavelength, nm (spectrum)	445 (blue), 525 (green), 635 (red), 780, 808, 904 (IR)	Emitting head with one laser

Table 1 ending

Parameter	Value	Notes
Laser operational mode	Continuous	445, 525, 635, 780, 808nm
	Pulsed	635 and 904nm
Duration of the light pulse, ns	100–150	For pulsed mode
Power	10–40mW	Continuous mode
	5–25W	Pulsed mode
Power density (More absorption – less value)	5–40mW/cm ²	Continuous mode
	5–15W/cm ²	Pulsed mode
Frequency, Hz	80–150	For pulsed mode
Exposure per one zone, minutes	2 or 5	–
Number of the exposed zones	1–4	–
Localization	On affected area	–
Technique	Contact-mirror	With the use of a mirror (ZN-35 or ZN-50) or magnetic nozzle attachment ZM-50 (Fig. 3)
Number of procedures per course	5–12	Daily or on alternate days

Table 2

Parameters of contact technique for matrix laser emitting heads

Parameter	Value	Notes
Laser light wavelength, nm (spectrum)	635 (red)	–
	904 (IR)	
Laser operational mode	Pulsed	Matrix emitter consisting of 8 laser diodes of the total surface area of 10cm ²
Duration of the light pulse, ns	100–150	For pulsed mode
Power, W	35–40	635nm
	60–80	904nm
Power density, W/cm ²	4–5	635nm
	8–10	904nm
Frequency, Hz	80–10,000	Depending on the depth of the intended exposure and wavelength
Exposure per one zone, minutes	1.5–2 or 5	–
Number of the exposed zones	1–4	–
Localization	On the affected area and the projection of the internal organs	–

Table 2 ending

Parameter	Value	Notes
Technique	Contact	Through a transparent nozzle PMN
Number of procedures per course	5–12	Daily or on alternate days

Table 3

Parameters of contact low level laser therapy technique

Parameter	Value	Notes
Laser light wavelength, nm (spectrum)	780, 808, 904 (IR)	Emitting head with one laser
Laser operational mode	Continuous	780nm and 808nm
	Pulsed	904nm
Duration of the light pulse, ns	100–150	For pulsed mode
Power	100–200mW	780 and 808nm
	80–100W	904nm
Power density	–	The maximum possible
Frequency, Hz	3000–10,000	For pulsed mode
Exposure per one zone, minutes	5	In some techniques exposure is allowed to be up to 30 minutes
Number of the exposed zones	1–4	Most often symmetrically
Localization	On affected area	–
Technique	Contact	Directly touching the surface with the laser diode
Number of procedures per course	15–20	Generally this is done daily. The course is repeated in a month

The frequency for *pulsed lasers* varies depending on the desired effect: regeneration – 80–150Hz, anesthesia – 3,000–10,000Hz. One area includes up to 2–3 local zones, the exposure for each zone being 2–5 minutes. It is strictly forbidden to illuminate one area for more than 5 minutes.

Local action of LILI on the projection of the affected organ of body differs from surface illumination, as only pulsed infrared lasers are used, and matrix lasers are desirable to ensure a therapeutic effect at a depth of 15cm: wavelength 890–904nm, PD – 8–10W/cm², pulse duration of 100–150ns, frequency of 80–10,000Hz (Table 2). By increasing the fre-

quency in pulsed lasers, the average illumination power increases proportionally as well, which allows the influencing of deeper areas. It is strictly forbidden to illuminate one area for more than 5 minutes.

Laser acupuncture (laserpuncture) is carried out by means of a special acupuncture nozzle designed for concentrating the laser light energy into a zone of 1–2 mm in diameter. The wavelength is 635nm (red spectrum), continuous or modulated modes are used, nozzle output power is 2–3mW, exposure per one corporal acupuncture point ranges from 20 to 40s, making it 5–10s per auricular point. It is unacceptable to exceed the specified exposure time (Table 4).

Table 4

Parameters laser acupuncture technique

Parameter	Value	Notes
Laser light wavelength, nm (spectrum)	525 (green)	On auricular AP
	635 (red)	On corporal AP
Laser operational mode	Continuous or modulated	–
Frequency, Hz	In a recipe	Only for modulated mode
Power*, mW	0.5–1	525nm
	2–3	635nm
Exposure per 1 AP, s	5–10	On auricular AP
	20–40	On corporal AP
Number of the exposed zones	Up to 15	–
Localization	In a recipe	On auricular AP
	In a recipe	On corporal AP
Technique	Contact	Through an acupuncture nozzle
Number of procedures per course	10–12	Daily

* – at the output of an acupuncture nozzle.

Laser blood illumination provides for two options for a procedure: via intravenous or non-invasive (extravenous, external, percutaneous, transcutaneous) access. Accordingly, these are called intravenous laser blood illumination (ILBI) and non-invasive (extravenous, transcutaneous, percutaneous) laser blood illumination (NLBI).

The Matrix and LASMIK devices (Fig. 4) allow to carry out both intravenous and non-invasive laser blood illumination, as well as other

methods of laser exposure. The maximum effectiveness of treatment is also based on the optimized design of the laser heads, e.g. a special system of fixing disposable light guides and the heads on the arm is used for ILBI (Fig. 4, bottom left), matrix emitting heads are used for NLBI (Fig. 4, bottom right, and Fig. 5).



Fig. 4. Laser therapeutic device “LASMİK”

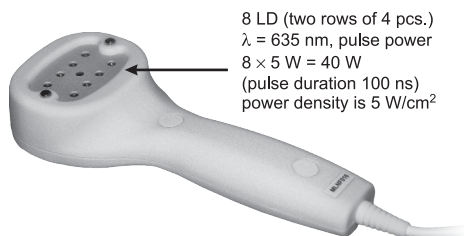

8 LD (two rows of 4 pcs.)
 $\lambda = 635 \text{ nm}$, pulse power
 $8 \times 5 \text{ W} = 40 \text{ W}$
 (pulse duration 100 ns)
 power density is 5 W/cm^2

Fig. 5. The Matrix laser emitting head ML-635-40 for NLBI, contact and distant techniques, as well as for the projection of the internal organs

For ILBI, LILI is always used in continuous mode, laser action is carried out intravenously through a special disposable sterile light guide with a puncture needle (Fig. 6) most often in the cubital vein (Fig. 7 and Fig. 8, zone 1) [Geynits A.V., Moskvina S.V., 2009; Geynits A.V. et al., 2009, 2012].

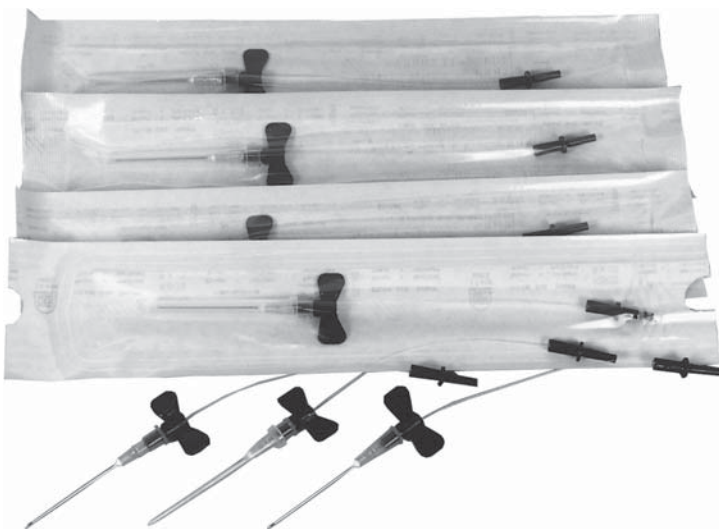

Fig. 6. Disposable sterile light guides for ILBI procedure

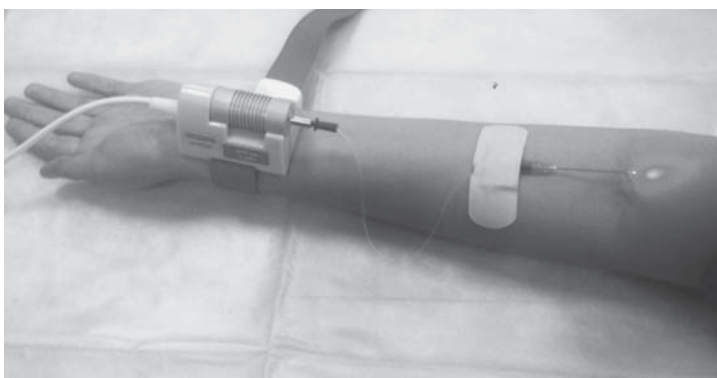

Fig. 7. The ILBI procedure

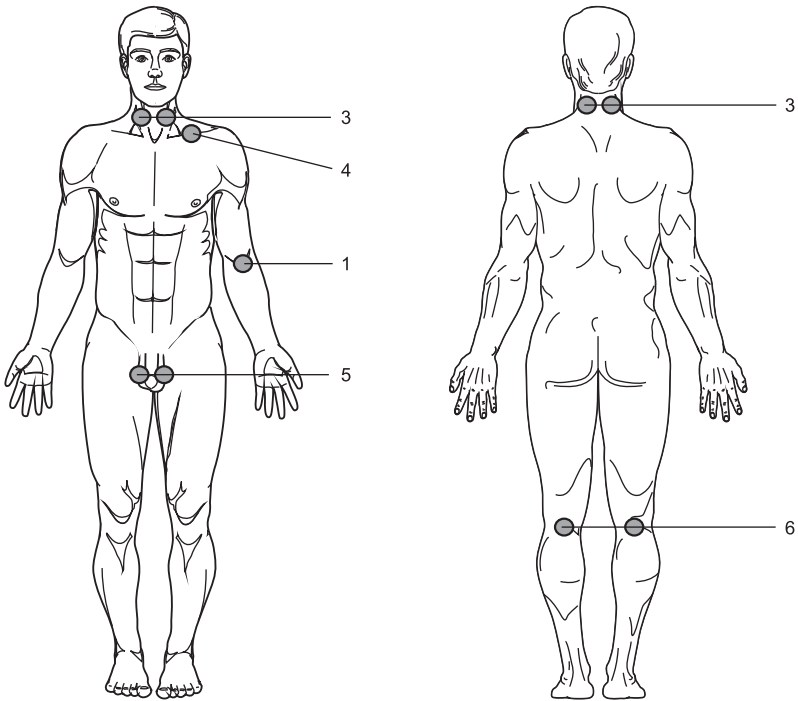

Fig. 8. The basic exposed zones for laser blood illumination

To implement ILBI, different techniques are currently applied using laser light of a different spectra (Tables 5, 6):

ILBI-635 (wavelength 635nm, red spectrum, power 1.5–2mW, exposure for 10–20 minutes) has a universal effect, making a positive impact both on the immune system, and provides the trophic support of tissues.

ILBI-525 (wavelength 525nm, green spectrum, power 1.5–2mW, exposure of 7–8 minutes) is recommended to ensure maximum gain of trophic support of tissues.

ILBI-405 (wavelength 365–405nm, power 1.5–2mW, exposure of 3–5 minutes) or *laser ultraviolet blood illumination (LUVBI®)* should be preferably used for the correction of immune disorders of various etiologies.

Table 5

ILBI-525 + LUVBI® technique (basic)

Parameter	Value	Notes
Laser light wavelength, nm (spectrum)	365–405 (UV)	LUVBI®
	520–525 (green)	ILBI-525
Laser operational mode	Continuous	–
Power*, mW	1.5–2	At the output of a disposable light guide
Exposure, minutes	3–5	LUVBI®
	7–8	ILBI-525
Localization	Median cubital vein (v. <i>mediana cubiti</i>)	–
Technique	Intravenously	Through a disposable sterile light guide
Number of procedures per course	10–12	Daily, alternating ILBI-525 and LUVBI® every other day

Table 6

ILBI-635 + LUVBI® technique

Parameter	Value	Notes
Laser light wavelength, nm (spectrum)	365–405 (UV)	LUVBI®
	635 (red)	ILBI-635
Laser operational mode	Continuous	–
Power*, mW	1.5–2	At the output of a disposable light guide
Exposure, minutes	3–5	LUVBI®
	10–20	ILBI-635
Localization	Median cubital vein (v. <i>mediana cubiti</i>)	–
Technique	Intravenously	Through a disposable sterile light guide
Number of procedures per course	10–12	Daily, alternating ILBI-635 and LUVBI® every other day

Non-invasive laser blood illumination (NLBI) is carried out on large blood vessels, adjacent to the center of the lesion focus. Pulsed lasers, preferably of the red (635nm) and infrared (890–904nm) spectra and matrix emitters (8 laser diodes) or, as an option, a single laser with a mirror nozzle are used mainly for NLBI (Table 7) [Moskvin S.V. et al., 2007]:

- pulsed LILI of red spectrum (635nm), PD – 4–5W/cm², pulse duration of 100–150ns, frequency of 80Hz,
- pulsed infrared LILI (890–904nm), PD – 8–10W/cm², pulse duration of 100–150ns, frequency of 80Hz.

Table 7

Technique NLBI

Parameter	Value	Notes
Laser light wavelength, nm (spectrum)	635 (red)	NLBI-635
	904 (IR)	NLBI-904
Laser operational mode	Pulsed	–
Duration of the light pulse, ns	100–150	–
Power, W	30–40	Matrix emitting head, NLBI-635
	60–80	Matrix emitting head, NLBI-904
Power density, W/cm ² (surface area 10cm ²)	3–4	NLBI-635
	6–8	NLBI-904
Frequency, Hz	80–150	–
Exposure per one zone, minutes	2–5	–
Number of the exposed zones	2–4	Symmetrically
Localization	On the projection of large blood vessels close to the lesions	Refer to the text
Technique	Contact	Through a transparent nozzle
Number of procedures per course	10–12	Daily

The following exposure localizations are used for NLBI (Fig. 6):

- projection of the common carotid artery (sinocarotid zone) symmetrically,
- projection of the vertebral artery symmetrically (zone 3),
- left supraclavicular area (zone 4),
- vascular bundles in the groin symmetrically (zone 5);
- popliteal fossa symmetrically (zone 6).

Pulse repetition frequency is fixed (80–150Hz), the question of possibility and admissibility of increasing the frequency (i.e. the average power for pulsed lasers) has not been studied at present. It is recommended to illuminate symmetrical zones, the exposure for each zone needs

to be 2–5 minutes. It is strictly forbidden to illuminate one area for more than 5 minutes!

The Intracavitary procedure is intended to deliver laser light energy to the affected area, located in a natural cavity (endonasal, endoauricular, etc.), via a special light guide instrument (optical fiber). A feature of this procedure is the need to introduce most of the energy in the fiber, followed by its distribution inside along the given indicatrix, however, since PD is not always determined in this case, the illumination power is set at the nozzle inlet, i.e. is measured without the nozzle. The following procedures are used most often for laser exposure:

- continuous LILI of the red spectrum (635nm), power – 10–15mW,
- pulsed LILI of the red spectrum (635nm), power – 4–5W, pulse duration 100–150ns, frequency of 80–150Hz,
- pulsed infrared LILI (890–904nm), power – 15–20W, pulse duration 100–150ns, frequency of 80–10,000Hz.

To deliver pulsed IR LILI (890–904nm), it is required to use only the quartz-polymer fiber, as the polymer (PMMA) absorbs nearly all the illumination with wavelengths longer than 830nm. It is strictly forbidden to illuminate one area for more than 5 minutes.

Laser phoresis is one of the more modern practices of physical and pharmacological methods of the combined percutaneous application of LILI and medicinal preparations. As a result of LILI, the area which is previously applied with the biologically active substance in the form of gel or an aqueous solution, its penetration through skin (pores, hair follicles) is activated. This such percutaneous injection-free method of substance administration is possible only with low molecular weight (no more than 500 kDa) and hydrophilic compounds [Moskvin S.V., Konchugova T.V., 2012].

The technique parameters:

- continuous LILI of the red spectrum (635nm), PD – 10–15mW/cm²,
- continuous infrared LILI (780–790nm), PD – 40–50mW/cm²,
- pulsed infrared LILI (890–904nm), PD – 8–10W/cm², pulse duration of 100–150ns, frequency of 80Hz.

For pulsed lasers frequency is not changed. One area may have up to 15–20 local areas, with an exposure time of 1–1.5 minutes for each zone, but no more than 20 minutes in total.

The presented principles of the low level laser therapy procedures formation may be adjusted in some cases, except for the exposure. Varying the exposure time is not allowed, because it is determined by physiological rhythms, synchronization with which necessarily underlies any laser treatment techniques. In some cases, it is possible to adjust LILI energy parameters, for example, for pain relief or suppression of excessive proliferation it is required to set up extremely high frequencies – up to 10,000Hz (recommendation refers exclusively to the pulsed lasers with a pulse duration of 100–200ns and pulsed (peak) output power up to 300W).

SPECIAL TECHNIQUES OF LOW LEVEL LASER THERAPY

Obstetrics and Gynecology

Acute Bartholinitis (in the Infiltration Phase), Subacute and Chronic

Contraindications: acute bartholinitis in the stage of abscessing, festering cysts of the Bartholin's glands (when cysts and recurrent pseudoabscesses of the large gland of the vestibule occur, LLLT is recommended in the preoperative preparation plan [3–5 procedures], thus, the period of healing of the postoperative seam is accelerated, and the percent of postoperative suppurations is decreased).

LLLТ technique is contact-mirror (Table 1) or contact (Table 2), stable in the projection to the affected gland, and consists of 3–5 daily procedures per course [Fedorova T.A. et al., 2009].

Purulent-Septic Complications

ILBI is recommended in any of the combined options (Table 5 or 6) to women both not pregnant and during pregnancy with a high risk of the development of pyo-inflammatory complications:

- with chronic salpingo-oophoritis, endometritis, colpitis;
- having surgery in the anamnesis, birth complications due to pyo-inflammatory diseases;
- having chronic viral infections, suffering from miscarriages, having premature birth in the anamnesis, pre-natal destruction of fetuses or birth of children with pre-natal infections.

For relieving the inflammation process in the genitals and the pelvic organs caused by a cytomegalovirus infection of the urogenital tract, at its reactivated current, a combined option of ILBI (Table 5) is implemented alongside antiviral therapy. There are 15 procedures per course, 8 LUVBI® procedures and 7 ILBI-525 procedures [Patent 2513474 RU].

Coleitis, Cervicitis (Endocervicitis)

Indications: subacute and chronic serous-purulent, fungoid, senile colpitis, herpetic colpitis. LLLT of senile colpitis is the most effective. With

all kinds of colpites, LLLT is implemented alongside standard medication with a daily vaginal sanitation before the procedure.

Technique 1. Combined. The exposure is implemented intravaginally (Fig. 9) with a KLO-635-15 emitting head (wavelength is 635nm, continuous mode, maximum power is 10–15mW) with a G-3 gynecology nozzle. A condom – which is lubricated with the appropriate preparation – (depending on the disease profile) is put on the nozzle, [Fedorova T.A. et al., 2009].

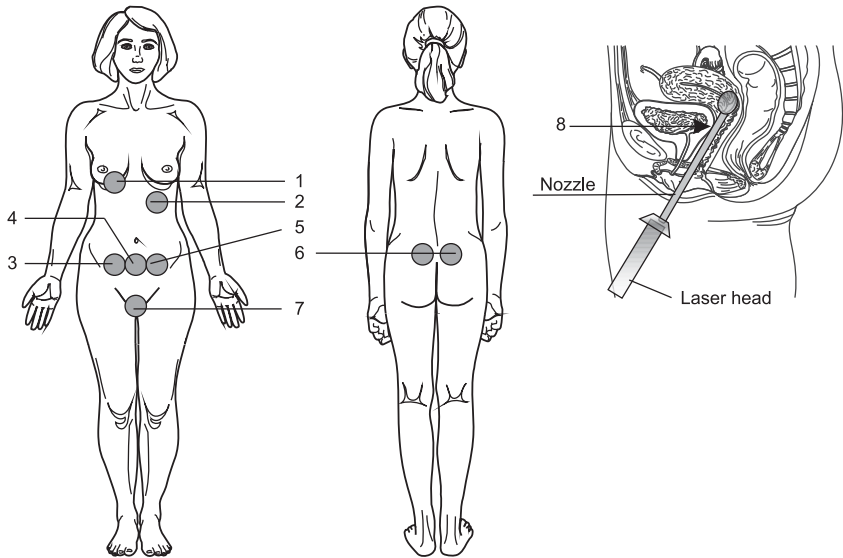

Fig. 9. Laser exposed zones in gynecology

Then the exposure is implemented with the matrix emitting head (Table 2) on the area of the vaginal opening (Fig. 9) at a distance of 1cm for two minutes in a stable manner, and on the painful zones (Fig. 9, zone 6) in the sacrum-lumbar region (defined by palpation).

Technique 2. Laser acupuncture and locally. An approximate scheme of the acupuncture points is shown (Fig. 10), in addition to the “basic procedure” (Fig. 11):

1st procedure: intravaginal (Fig. 9), pulse repetition frequency is 80–150Hz, the exposure is 2 minutes + laser acupuncture (Table 4) “basic procedure” (Fig. 11).

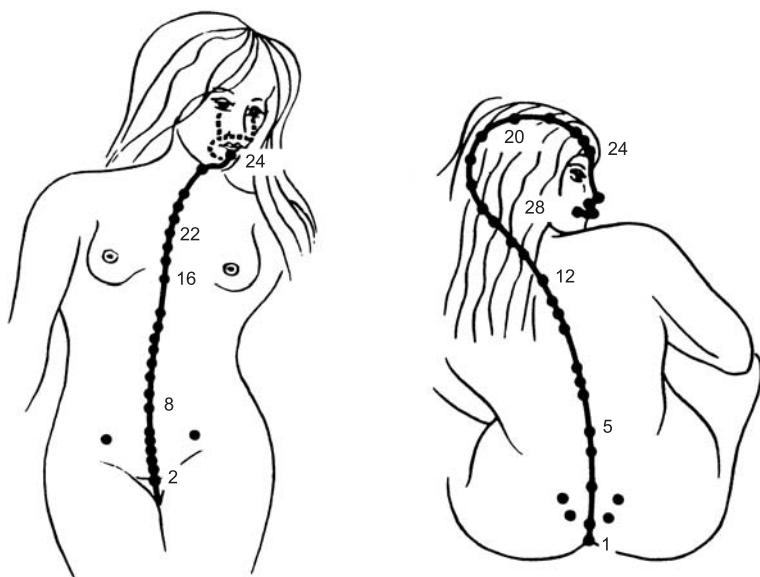

Fig. 10. Exposed zones (projection of appendages, pain zones in the sacrum area, acupuncture points on the VC and VG meridians)

2nd procedure: intravaginal (Fig. 9), pulse repetition frequency is 80–150Hz, the exposure is 2 minutes + external illumination of the introitus at the distance of 1–2cm using the scanning method for two minutes (Table 1, LO-904-20 laser head, wavelength is 904nm, pulse mode, maximum power is 15–20W, frequency is 80–150Hz) + laser acupuncture (Table 4) on the points: V53, V58.

3rd procedure: 2nd procedure parameters + laser acupuncture (Table 4) on the points: R4, R10, V55.

4th procedure: intravaginal (Fig. 9), pulse repetition frequency is 80–150Hz, the exposure is two minutes + external illumination for one minute (Table 1, LO-904-20 laser head, wavelength is 904nm, pulsed mode, maximum power is 15–20W, frequency is 1500Hz) + laser acupuncture (Table 4) on the points: VB28, VB29, F2.

5th procedure: 4th procedure parameters + laser acupuncture (Table 4) on the points: F10, F11, VC1.

6th procedure: intravaginal (Fig. 9), pulse repetition frequency is 80–150Hz, the exposure is four minutes + external illumination for one

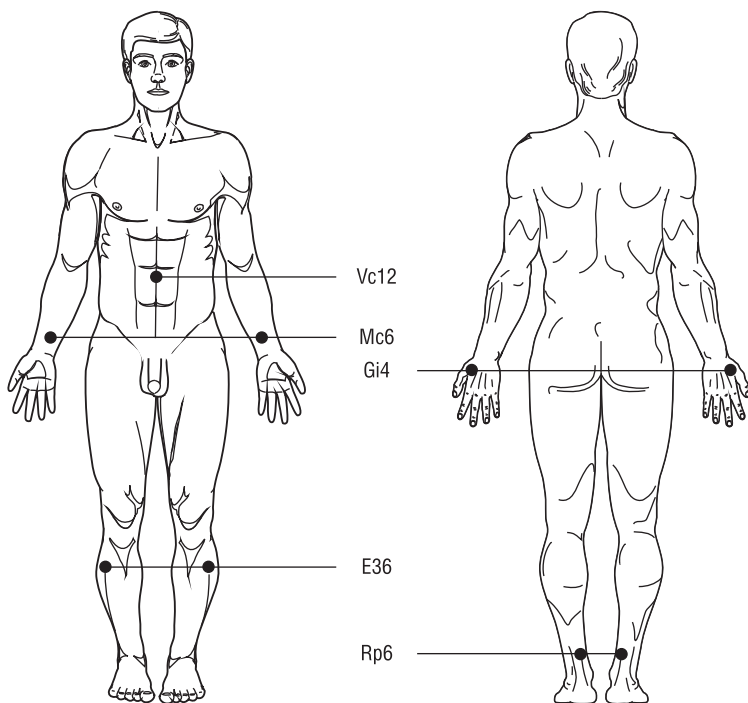

Fig. 11. "Basic recipe" of laser acupuncture

minute (Table 1, LO-904-20 laser head, wavelength is 904nm, pulse mode, maximum power is 15–20W, frequency is 1500Hz) of the lumbar-sacrum region (2–3) + laser acupuncture (Table 4) on the points: VC2, F12, VB27.

7th procedure: 6th procedure parameters + laser acupuncture (Table 4) on the points: G110.

8th procedure: intravaginal using the scanning method, making circular motions over the vaginal vaults and walls from the cervix to the vaginal opening for four minutes (Table 1, LO-904-20 laser head, wavelength is 904nm, pulse mode, power maximum is 15–20W, frequency is 1500Hz), external illumination of the introitus for one minute (frequency is 80–150Hz) and of the centre of the Rhombus of Michaelis for one minute with the help of the contact-mirror technique (Table 1) + laser acupuncture (Table 4) on the points: P7, R6.

9th procedure: 8th procedure parameters + laser acupuncture (Table 4) on the points: R3, R12.

10th and 11th procedures: intravaginal with pulse repetition frequency of 80–150Hz for five minutes; external illumination of the introitus 80–150Hz for one minute, of the center of the Rhombus of Michaelis and of the center of the suprapubic area with a frequency of 80–150Hz for half a minute, followed by laser acupuncture (Table 4) on the points: TR5, VB39, VB41.

12th and 13th procedures: intravaginal scanning over the whole vaginal area for two minutes (Table 1, the LO-904-20 laser head, wavelength is 904nm, pulse mode, maximum power is 15–20W, frequency is 80–150Hz). No laser acupuncture.

The repetition of this course is possible within a month. Before implementing low level laser therapy, an oncocytologic examination of the smears from the vaginal part of the cervix, of the aspirate from the cervical canal is necessary.

ILBI has an immunomodulatory and anti-inflammatory effect, it stimulates the microcirculation and regeneration processes, it is implemented by any of the combined options (Table 5 or 6). In addition, the direct exposure of the eroded surface of the cervix is implemented daily with the KLO-635-15 head (wavelength is 635nm, continuous mode, power maximum is 10–15mW) with the help of the G-1 or G-2 nozzles. The first session is three minutes, and can be increased further down the line by one minute, with the maximum being five minutes.

Kraurosis Vulvae, Idiopathic Neurogenic Vulva Itching

This therapy is implemented together with medication. It is recommended to take a biopsy from the areas that are suspicious of malignant degeneration, conduct an oncocytologic examination of the smears of the vaginal portion of the cervix of the aspirate of the cervical canal. Contraindications: vulva cancer, itching of the vulva against alongside diabetes and helminth infestation.

LLLT technique is done from a distance, labile (Fig. 3, the distance from the laser head is 1cm), scanning of the kraurosis center (labia majora, labia minorum, pubis, perineum) (Fig. 9), then the contact-mirror technique in a stable manner on zones 4 and 6 (Fig. 9) (Table 1, LO-904-20 laser emitting head with ZM-50 magnet nozzle head, wavelength is 904nm, pulse mode, maximum power is 15–20W, frequency is 80–

150Hz). The second course of treatment is implemented for 3–4 weeks, if necessary.

True Erosions and Cervical Pseudo Erosions

To achieve an effective therapeutic effect, it is necessary to select patients who require low level laser therapy meticulously, and they are shown the application of the method without taking into account the objective criteria, the indications and contraindications to the choice of treatment leads to the decrease of the efficiency and to the discredit of the method.

It is best to start the therapy after the end of regular menstruation in the first phase of the menstrual cycle. The procedures are implemented every day, preferably at the same time. The total number of the procedures per course of treatment is on average between 15–20. With positive dynamics the duration of the course of the treatment can be increased.

The procedure is implemented on a gynecological chair or on a couch. The cervix is denuded in the mirrors, the mucus and discharge are carefully removed with a cotton swab. The entire erosion area is exposed using one of the following options [Fedorova T.A. et al., 2009]:

- 1) directly with the laser head at a distance;
- 2) through a system of mirrors;
- 3) through special gynecology nozzles G-1 or G-2.

The parameters of the procedure for continuous LLLT with a wavelength of 635nm: KLO-635-15 laser head, maximum power is 10–15mW, exposure is 1.5–2 minutes.

The parameters of the procedure for pulsed IR LLLT with a wavelength of 904nm: LO-904-20 laser head, wavelength is 904nm, pulse mode, maximum power is 15–20W, frequency is 80–150Hz, exposure is 1.5–2 minutes.

Some Types of Infertility, Ovarian Hypofunction, Some Forms of Diencephalic Pathology and Hypothalamo-Pituitary Disorders

Diencephalic, hypothalamic and pituitary structures responsible for the regulation of the central parts of the reproduction system are activated with the help of intranasal illumination.

The parameters of the procedure for continuous LLLT with a wavelength of 635nm: KLO-635-15 laser head, power is 8–12mW, exposure is 1.5–2 minutes on each area.

The parameters of the procedure for pulsed IR LLLT with a wavelength of 904nm: LO-904-20 laser head, wavelength is 904nm, pulse mode, power is 10–15W, frequency is 1500–3000Hz, exposure is 1.5–2 minutes on each area.

The course consists of 5–8 procedures (sessions). The first session is implemented on the 1st–2nd day after the end of regular menstruation. Then the sessions are implemented every day, once a day, at the same time preferably. The exposure is intranasal with the help of the L-1-2 nozzle (from the set of otolaryngology nozzles) which is injected at the depth of 2–5cm in each nasal passage.

Together with the intranasal exposure the illumination of the ovaries is implemented, same as in the rehabilitation course of patients with dysfunctional uterine bleeding (DUB). The exposure is implemented through the vaginal vaults or through the anterior abdominal wall [Fedorova T.A. et al., 2009].

ILBI has an immunomodulatory and anti-inflammatory effect, blood rheology is improved, metabolic processes and body defenses are normalized. In 2–3 months after the course of LLLT, women's menstrual cycles and hormonal disorders are normalized, in half the cases the degenerative changes of the nuclear material disappear and the number of oocytes with a normal structure is increased [Ivanyuta L.I. et al., 2001].

ILBI technique (Table 5 or 6), there are 5–6 daily procedures per course of treatment, beginning on the 7th day of the cycle.

Low level laser therapy is recommended with primary algodismenorrhea. With secondary algomenorrhea, especially connected with endometriosis, LLLT is not as efficient. The therapeutic effect of LLLT is connected with the primary analgesic and antispasmodic effects, and with the microcirculation improving. Even more so, the activation of steroidogenesis and possibly some other mediated influences of laser illumination on the exchange of prostaglandins have a positive effect as well.

The ovaries from both sides, the uterine body and the area of the external orifice of the cervical canal are exposed additionally. While implementing the exposure through the anterior abdominal wall, 3 fields are used: at the points of ovaries' projection and over the womb along the middle line in the direction of the uterine body. With the use of the intravaginal nozzles (G-1, G-2 and G-3) the illumination of the uterine body is implemented through the anterior vaginal vault or posterior vaginal vault depending on the uterine position. The exposure of the uterine

appendages and the external orifice of the cervical canal is implemented in the same way that the treatment of patients with dysfunctional uterine bleeding (DUB) (see below).

The course of treatment includes 6–9 LLLT procedures, 3–4 sessions are implemented in the first phase of the cycle after the end of regular menstruation. The rest of the 3–5 procedures are implemented in the second phase of the menstrual cycle directly at the beginning of the following menstruation.

Nonspecific Salpingitis and Salpingoophoritis (Subacute and Chronic)

Low level laser therapy implementation with the acute process is possible only after the end of the exudative inflammation phase. The treatment should be started at the end of the acute stage of inflammation, at the transition from the acute process to the subacute, from the exudative phase to the proliferative. It is necessary to empty the bladder before the procedure. The female patient should be placed on a couch in the supine position with her knees bent and pelvis up for the better accessibility to the appendages.

The LLLT course is implemented alongside the use of standard medication. [Fedorova T.A. et al., 2009].

The technique is contact, stable, transdermal (Table 2) on the zones of the projection of the uterine appendages, successively for 1.5–2 minutes on zones 1, 2, 3, 4, 6 (with moderate compression of soft tissues) (Fig. 9), frequency is 80–150Hz.

It is possible to implement the intracavitary technique over the vaults (Fig. 9, zone 8). The posterior and lateral vaginal vaults are exposed for two minutes for each field every other day or every day with the KLO-635-15 head (wavelength is 635nm, continuous mode, maximum power is 10–15mW) with the help of G-1 or G-2 nozzle. *On these days the transdermal exposure is not implemented.*

Complex therapy of patients with acute salpingoophoritis together with the use of ILBI leads to reduce the treatment duration, to the normalization of the hemoglobin level, of the dry weight of red blood cells and of the indicators of their osmotic resistance, of the quantity of normal discocytes, and of the size of the central depression of erythrocytes. With the help of these mechanisms local physiological processes are realized, the activation of microcirculation and the enhancement of tissue oxyge-

nation in particular, which, in its turn, leads to the increase of the intensity of energy, synthetic and proliferative processes in blood cells and tissues [Davydova Yu.G., 1996].

ILBI technique (Table 5 or 6), there are 5–7 daily procedures per course.

Menstrual Disorder, Ovarian Dysfunction and Algodismenorrhea

After the confirmation of the fact that LLLT influences the cortical activity, the activity of the whole range of the subcortical nuclei (supraoptic, paraventricular, etc.), the activity of the pituitary gland, adrenal glands and ovaries, that is, the endocrine system as a whole, low level laser therapy began gaining more and more application in gynecological practice for the regulation of the menstrual, ovarian dysfunction treatment, algodismenorrhea treatment, ovulation stimulation in the treatment of infertility and to treat some neuroendocrine syndromes.

There are two stages in, as well as in the application of traditional methods in the treatment of patients with dysfunctional uterine bleeding (DUB). During the first stage, the bleeding is stopped, and at the second stage the menstrual function is normalized.

LLLT procedure. The cervix is denudated in the mirrors and dried with a cotton swab, the external orifice of the cervical canal is exposed. It is necessary to provide the alignment of the laser light and the cervical canal during the procedure.

LLLT technique during the first stage. KLO-635-15 head (wavelength is 635nm, continuous mode, maximum is 10–15mW) with the help of the G-1 or G-2 nozzles, duration 4–5 minutes.

If the bleeding is stopped with the help of LLLT (to achieve this, at least 3 to 10 procedures are necessary), the hemostatic effect is proceeding during the first year of 2/3 of patients. Nevertheless, to achieve a stable continuous effect, it is advised to implement low level laser therapy rehabilitation courses after 3–6 menstrual cycles. The rehabilitation courses are aimed at mild stimulation of the central and peripheral parts of the reproductive system, at the normalization of the cyclic secretion of gonadotropins, and respectively, at the normalization of ovarian and uterine cycles.

LLLT technique during the second stage. The course of low level laser therapy is prescribed in the first phase of the cycle, right away after

the end of the regular menstruation. The procedures are implemented every day, one time a day, at the same time preferably, and the course duration is 7–12 days depending on this particular patient's menstrual cycle duration.

The ovaries and the external orifice of the cervical canal are exposed. The irradiation is brought with the help of the vaginal nozzle (G-2) on the right and left uterine appendages (wavelength is 635nm, continuous mode, maximum power is 10–15mW), and on the area of the external orifice of the cervical canal for 1.5–2 minutes – the contact-mirror technique (Table 1, wavelength is 904nm, pulse mode, frequency is 80–150Hz).

If the female patient is *virgo*, the exposure of the appendages is implemented through the anterior abdominal wall for 1.5–2 minutes on each side (Table 2, wavelength is 904nm, frequency is 1500Hz) with the moderate pressing the anterior abdominal wall for a deeper penetration of laser light [Fedorova T.A. et al., 2009].

Puerperal Endometritis

Low level laser therapy alongside the appropriate antibacterial treatment has an anti-inflammatory, analgesic, immunomodulatory and antispasmodic effect.

The procedures are implemented every day, 2–3 times a day with the intervals of 3–4 hours for 2–3 days. The technique is contact (Table 2, wavelength is 904nm, frequency is 80–150Hz) for 1.5–2 minutes successively on zones 3, 4, 5, 6, 7 (Fig. 9).

Cracked Nipples, Lactostasis, Puerperant Hypogalactia

In the treatment of cracked nipples and in the prevention of lactostasis, LLLT is implemented on the reflexogenic zones of mammary glands which are rich in nerve endings. Laser light does not significantly influence the prolactin level of puerperas with the normal level of lactation, and stimulates the prolactin level and lactation of puerperas with hypogalactia together with cracked nipples. LLLT facilitates the reduction of the level of the follicle-stimulating hormone of puerperas, but does not influence greatly on the level of luteinizing hormone, estradiol and progesterone. It considerably influences a puerpera's immune system, the humoral link is activated, the levels of Ig A, M, G and lactoferrin in the blood serum are increased, the stabilizing effect on the level of trophoblastic beta-glycoprotein in the blood serum is achieved.

Contraindications: fibrocystic nodular breast disease, mixed with prevalence of a cystic component.

The treatment of patients with lactostasis is implemented in two stages: first, the area of a nipple and areola (Fig. 12, zone 1) is exposed at a distance (the distance is 1cm) in a slow circling motion (Table 2, wavelength is 635nm or 904nm, frequency is 80–150Hz). Then, successively, upper-outer, upper-inner, lower-inner, lower-outer quadrants of the mammary gland are exposed with the LO-904-20 head with ZM-50 magnetic nozzle (wavelength is 904nm, pulse power is 10–15W, frequency is 80–150Hz) in a stable manner for one minute on the zone or in a slow circling motion for two minutes (zone 2). Pumping is recommended for an hour after the exposure.

For *cracked nipples* healing laser exposure (Fig. 12) is implemented on the nipple (zone 1) using slow circling motions after the prior removal of the remnants of milk and wound exudate.

Late Toxemia of Pregnancy (EPH-Gestosis)

ILBI technique (Table 5 or 6), there are 5–7 procedures per course, every day or every other day.

Prevention of Postoperative Complications

ILBI technique (Table 5 or 6), there are 5–7 daily procedures per course.

Fetoplacental Insufficiency

O.A. Vasilyeva (1998, 2006) considers ILBI to be very important in combined low level laser therapy (additionally, the external exposure

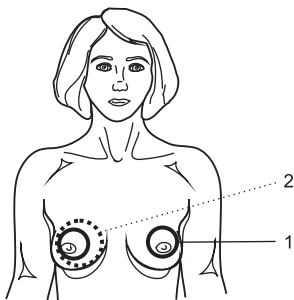

Fig. 12. Exposed zones for breast diseases

with pulsed IR LLLT on the projection of the uterine and the appendages alongside the taking of medicines) in the system of health improvement of the fetus and newborn at pregnancy with fetoplacental insufficiency. According to our data, complex treatment reduces the number of premature births from 66,7% to 17%, the number of cases of a long anhydrous period by 8.2 times, the number of abnormal births by 5.8 times while increasing the number of normal births by 1.8 times. ILBI-635 is also recommended for the prevention of perinatal complications of fetoplacental insufficiency [Kartelishev A.V. et al., 2004].

ILBI technique (Table 5 or 6), there are 5–7 daily procedures per course.

Endometriosis

ILBI technique (Table 6), the duration of ILBI-635 procedure is increased up to 30 minutes. There are 5–7 daily procedures per course in the lutein phase of the cycle [Mallak I.K., 1995].

Dermatology

Extremely high power density (PD) of LLLT and active implementation of conjoined and combined techniques are the characteristics of LLLT methodology in this field of medicine. As skin diseases are most often followed by the functional disorders of the ANS (autonomic nervous system) and the CNS (central nervous system), it is extremely important to evoke systemic responses of the body [Buylin V.A., Moskvina S.V., 2001, 2005; Geynits A.V., Moskvina S.V., 2010].

Acne

Laser acupuncture (Table 4), successively on the points: GI4, E40, P5, RP10, V13, E25, TR6. Then on the rash elements (papules, pustules) the exposure is implemented on the foci, the technique is contact through acupuncture nozzle A-3 (wavelength is 635nm, continuous mode, power is 5–10mW), the time of the exposure on each element is 0.5–1.5 minutes. The total time of the procedure is no more than 20 minutes.

The course consists of 8 procedures for 4 weeks:

- 1st week – 3 procedures every other day;
- 2nd and 3rd week – 2 procedures a week (with the interval of 2–3 days);
- 4th week – 1 procedure.

Alopecia

Despite the abundance of therapeutic methods, the efficiency of most of them is temporary; none of the known methods can guarantee from recurrence in the future. There are no effective preventive measures either.

Low level laser therapy, especially when combined with other methods, is favourably different because of its prolonged remission and less recurrence frequency, as LLLT influences not only the local processes, but systemic homeostasis as well.

Alopecia Areata

Laser acupuncture (Table 4), successively on the points: R7, GI4.

This is when the laser massage of the foci is implemented with the KLO-635-15 head with an acupuncture nozzle A-3 (wavelength is 635nm, continuous mode, maximum power – 10–15mW), stroking with the nozzle mechanically, with a little pressure, with helical motions from the center of the focus to its margins, the time of the exposure is 1.5–2 minutes. The speed of scanning is 1–2cm/s.

Then laser phoresis of the foci is implemented. Before, the hair growth stimulating preparations are applied: pentoxyphyllinum, minoxidil, etc. Laser exposure is implemented in a stable manner, at a distance (Table 2, wavelength is 635 or 904nm, frequency is 80–150Hz), the exposure on one zone can be up to five minutes.

The course consists of 8 procedures during 4 weeks:

- 1st week – 3 procedures every other day;
- 2nd and 3rd week – 2 procedures a week (with the interval of 2–3 days);
- 4th week – 1 procedure.

Total Alopecia

Laser acupuncture (Table 4), successively on the points: R7, GI4, J12, MC6, RP4, TR6, F5, V19, F3, VB25.

Then the exposure of the head from the top is implemented, the exposure is labile, at a distance (Table 2, wavelength is 635 or 904nm, frequency is 80–150Hz), the exposure on one zone is up to five minutes.

Then the projections of the upper cervical sympathetic ganglions are exposed symmetrically (Fig. 13). The technique is contact-mirror, stable, with the LO-904-20 head and the ZN-35 mirror nozzle (wavelength is 904nm, pulse mode, power is 10–15W, frequency is 80–150Hz), 1.5–2 minutes on each zone, 10–15 procedures per course of treatment.

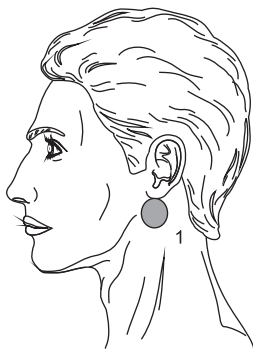

Fig. 13. The upper cervical sympathetic ganglion (ganglion servicalis)

The procedures end with the application of warm vitamin A and E oil solutions with massage movements, the head is covered with a plastic cap for 45 minutes, and after that the oil remains that haven't been absorbed are removed with a cotton swab moistened by camphor alcohol. Then the surface of a head is exposed at a distance, in a stable manner (wavelength is 635nm, modulated mode, modulation frequency is 10Hz, power is 5–10mW), the time of the exposure on one zone is one minute, the total time of the procedure is no more than five minutes. The patient is advised to massage their heads themselves head every day at home between the procedures with the application of vitamin A and E oils, after which, it is necessary to cover the head with a plastic cap.

The course consists of 15–20 procedures for 8 weeks. The first therapeutic effect, the growth of new thin vellus hair with the length of about 1–1.5cm on the forehead and crown, is detected by the end of the course. Thereafter the growth of vellus and terminal hair will intensify. By the end of the 12 weeks of treatment, a considerable increase of the volume of hair on the head with a gradual growth of the foci of the diffuse alopecia must be observed. The maximum effect is achieved after 7–9 months.

Vitiligo

A positive effect (complete or close to complete repigmentation) should be expected no earlier than in 6 months, that is due to physiological causes: it takes 2 months for the normal, complete replacement of the epidermis, the multiplication and movement of the melanocytes and

their function recovery are extremely slow too [Moskvin S.V., 2003; Yu H.S. et al., 2003].

Laser acupuncture (Table 4), successively on the points: P1 and V13.

Then the points of the meridian influence are stimulated, on their way the depigmented areas are located (Table 4, 8).

Table 8

Points of the meridian influence, on their way the depigmented areas are located with vitiligo

Meridian	Exposurepoint	Location at 1.5 cun from the middle line of the vertebral column
P (I)	V13	3rd thoracic vertebra
MC (IX)	V14	4th thoracic vertebra
C (V)	V15	5th thoracic vertebra
F (XII)	V18	9th thoracic vertebra
RP (IV)	V20	11th thoracic vertebra
R (VIII)	V23	2nd lumbar vertebra
GI (II)	V25	4th lumbar vertebra
TR (X)	V22	1st lumbar vertebra
IG (VI)	V27	Sacrum, 1st foramina
VB (XI)	V19	10th thoracic vertebra
E (III)	V21	12th thoracic vertebra
V (VII)	V28	Sacrum, 2nd foramina

Then the technique of the exposure of the depigmented areas is implemented along a spiral with the LO-904-20 head (wavelength is 904nm, pulse mode, maximum output power is 15–20W, frequency is 80–150Hz), the exposure on one zone is up to two minutes. The exposure is implemented with the taking of the healthy skin, moving from the periphery to the center.

The first therapeutic course consists of 12–15 daily procedures; the second course is implemented in 1.5–2 months.

The clinical efficacy of the technique (1.5–3cm decrease of the depigmented volume area, and their complete elimination with the effect being retained for up to 3 years) is up to 92% in the presence of dysfunctional melanocytes in the basal layer of the epidermis (the period from the beginning of the illness is up to 3–5 years).

Laser acupuncture moves the systemic homeostasis in the outer direction, raising the neurogenic “blockade” of the melanogenesis, and the

local impact of LLLT operates as a mild corrector of the local disorders, providing the recovery of the normal condition of the systems of the local regulation of the melanogenesis.

Recurrent Herpes Simplex

The greatest effect of low level laser therapy on herpes is obtained at the beginning of treatment, at the early stage of cutaneous manifestations – itching and burning, that is not later than 24 hours from the beginning of the disease [Votyakov V.I. et al., 1980]. Laser phoresis of viricides (acyclovirum) is the most effective [Semenova T.B., 1997].

Laser acupuncture (Table 4), successively on the points: GI4, GI11, RP10, P5.

Then the foci are exposed for one minute on each zone (at a distance) with the preliminary application of viricides on them – KLO-635-15 laser head (wavelength is 635nm, continuous mode, maximum power is 10–15mW).

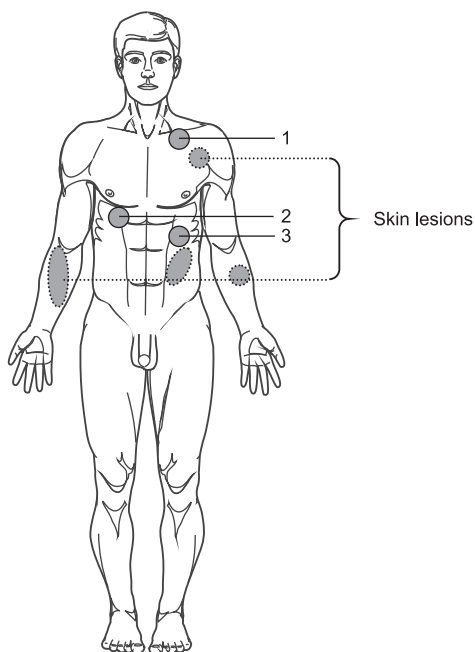

Fig. 14. Exposed zones for herpes and itching dermatitis

Then successively with the contact-mirror technique (Table 1), in a stable manner on zones 1, 2, 3 (Fig. 14), for 1.5–2 minutes on one field with the LO-904-20 and the ZN-35 mirror nozzle (wavelength is 904nm, pulse mode, power is 10–15W, frequency is 80–150Hz).

Pruritic Dermatitis (Atopic and Contact Dermatitis, Eczema, Lichen Planus, Localized Itching of the Skin)

A few (2–3) courses of low level laser therapy consisting of 10–12 daily procedures (sessions) are implemented for 3–4 weeks. The intake of sedatives is recommended during the first course.

LLLT technique is contact-mirror, in a stable manner on zones 1, 2, 3 (Fig. 14), for 1.5–2 minutes on one field with the LO-904-20 head with ZN-35 mirror nozzle (wavelength is 904nm, pulse mode, power is 10–15W, frequency is 80–150Hz).

Then the exposure of the foci (no more than three during one procedure (session) is implemented at a distance, in a stable manner or with slow scanning motions for 0.5–1 minute of each focus. The KLO-635-15 head (wavelength is 635nm, continuous mode, maximum power is 10–15mW), the exposure is two minutes on one field.

The procedures are concluded with ILBI (Table 5 with the amendments) [Patent 2562317 RU].

ILBI uses low-intensity continuous laser light of alternating wavelengths 365–405nm (UVA spectrum) and 520–525nm (green spectrum) with varying exposure for 12 daily sessions. The exposure conforms to the following schedule:

- 1st session – 365–405nm, power 1–2mW, exposure 2 minutes;
- 2nd session – 365–405nm, power 1–2mW, exposure 2 minutes;
- 3rd session – 365–405nm, power 1–2mW, exposure 2 minutes;
- 4th session – 520–525nm, power 1–2mW, exposure 7 minutes;
- 5th session – 365–405nm, power 1–2mW, exposure 3 minutes;
- 6th session – 520–525nm, power 1–2mW, exposure 10 minutes;
- 7th session – 365–405nm, power 1–2mW, exposure 3 minutes;
- 8th session – 520–525nm, power 1–2mW, exposure 10 minutes;
- 9th session – 365–405nm, power 1–2mW, exposure 2 minutes;
- 10th session – 520–525nm, power 1–2mW, exposure 7 minutes;
- 11th session – 365–405nm, power 1–2mW, exposure 2 minutes;
- 12th session – 520–525nm, power 1–2mW, exposure 5 minutes.

This method enables improving the treatment quality and efficacy of the patients with atopic dermatitis by the integrated effect on different links of the disease process.

Skin Angiitis (Vasculitis)

The complex conjoined LLLT method suggested by us allows the receiving of the highest clinical therapeutic results, which are combined with the veracious tendency to the normalization of the parameters of blood viscosity [Kiani Ali et al., 2005]. No more than 3–4 techniques a day. The course consists of 10–15 procedures (sessions), every day or every other day.

Laser acupuncture (Table 4), “basic recipe” (Fig. 11), every other day.

Then the local distant stable exposure on each limb for five minutes with the ML-904-80 matrix pulsed IR laser head (wavelength is 904nm, maximum power is 60–80W, frequency is 80–300Hz) is implemented.

The procedures are ended with ILBI (Table 5).

Granuloma Annulare

Low level laser therapy is implemented at a distance, in a stable manner with the ML-904-80 matrix pulsed IR laser head (wavelength is 904nm, maximum power is 60–80W, frequency is 80–150Hz), for two minutes on a field. To achieve a lasting result, it is advised to implement 2–3 repetitive courses of LLLT in 3–4 weeks [Kochetkov A.V., 2000].

Localized Scleroderma

There are 10–12 daily procedures per course of treatment. The repetitive courses (no less than 2–3) are advised to be done in 3–4 weeks [Podelinskaya L.V., 1996].

Technique 1. NLBI (Table 7, wavelength is 635nm) on the projection of the vascular bundles (radial, femoral and popliteal arteries) for two minutes [Bakhmetyev A.A., 2002].

Technique 2. The clavicle exposure is labile, distant with the ML-904-80 matrix pulsed IR laser head (wavelength is 904nm, power is 40–60W, frequency is 80–150Hz), for five minutes.

Technique 3. Paravertebrally on zones Th_I–Th_{XII}, the technique is contact-mirror, labile, with the LO-904-20 pulsed IR laser head with the

ZN-35 mirror nozzle (wavelength is 904nm, power is 10–15W, frequency is 80–150Hz), the exposure is one minute.

Technique 4. The foci exposure (no more than 3–4 zones during one procedure) is distant, in a stable manner, for 0.5–1 minute on a zone, KLO-808-200 laser head (wavelength is 808nm, power maximum is 180–200mW).

Herpes Zoster

Low level laser therapy during the first 3 days is aimed at the stimulation of the immune system. The technique is contact-mirror, stable on zones 1, 2, 3 (Fig. 14), for 1.5–2 minutes on one field with the LO-904-20 head and the ZN-35 mirror nozzle (wavelength is 904nm, pulse mode, power is 10–15W, frequency is 80–150Hz).

Then 9 procedures according to technique 1 or 2 (more preferable).

Technique 1. The exposure of the foci (not more than three during one procedure) is distant, in a stable manner or with slow scanning motions for 0.5–1 minute. The KLO-635-15 head (wavelength is 635nm, continuous mode, maximum power is 10–15mW), the exposure is for two minutes on one area. In addition, paravertebally by the contact-mirror technique the segments corresponding to the affected areas are exposed with the LO-904-20 pulsed IR laser head and the ZN-35 mirror nozzle (wavelength is 904nm, power is 10–15W, frequency is 80–150Hz), the exposure is one minute.

Technique 2. The exposure on the foci with the ML-904-80 matrix pulsed IR laser head (wavelength is 904nm, maximum power is 60–80W, frequency is 3000–10,000Hz during the first 3–4 sessions, 300–600Hz during the next 2–3 sessions and 80–150Hz during the last sessions), the time of the exposure on one affected zone is 1.5–2 minutes.

Pyoderma

ILBI technique (Table 6), there are 10–12 daily procedures per course [Shulga V.A., 1995].

Psoriasis

The procedures should be implemented in the afternoon. The courses should be repeated in 2 months. The total number of courses is 3–4.

It is **strictly forbidden** to drink alcohol or consume other inhibitors of catecholamine activity during the course of this treatment.

Technique 1. Combined. Consists of two components (Fig. 15, 16):

1. Electrophoresis of calcium chloride 2–5% on the clavicle (according to A.E. Sherbak), 6 minutes and 6 mA during the first procedures, increasing the time by two minutes every other procedure and the current by 2 mA, bringing the time to 16 minutes and the current to 16 mA, which allows the sympathetic nervous system to activate. The total number of the procedures (sessions) is 10–15.

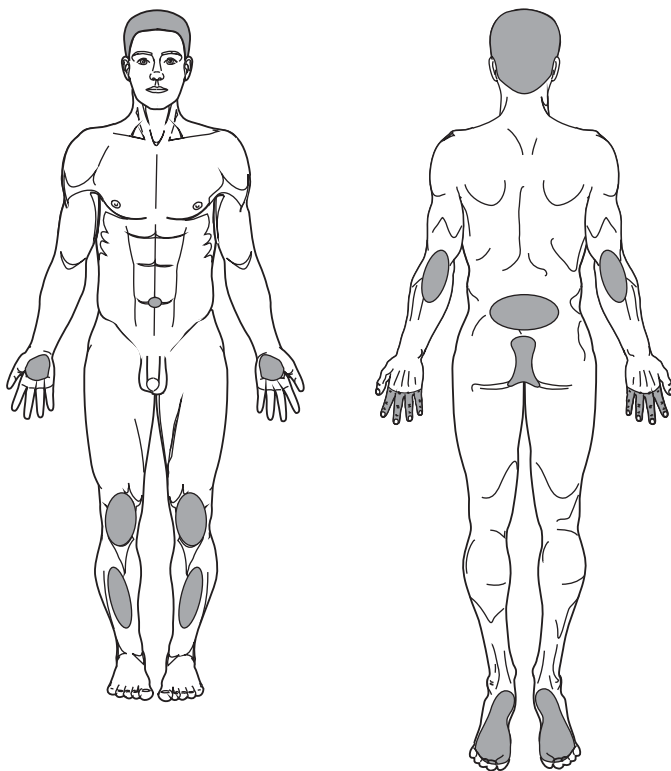

Fig. 15. Exposed zones for psoriasis

2. In 10–15 minutes after the electrophoresis, 10–15 daily procedures (sessions) per course, laser exposure is implemented according to the scanning technique with the ML-904-80 matrix pulsed IR laser head (wavelength is 904nm, maximum power is 60–80W, frequency is 80–

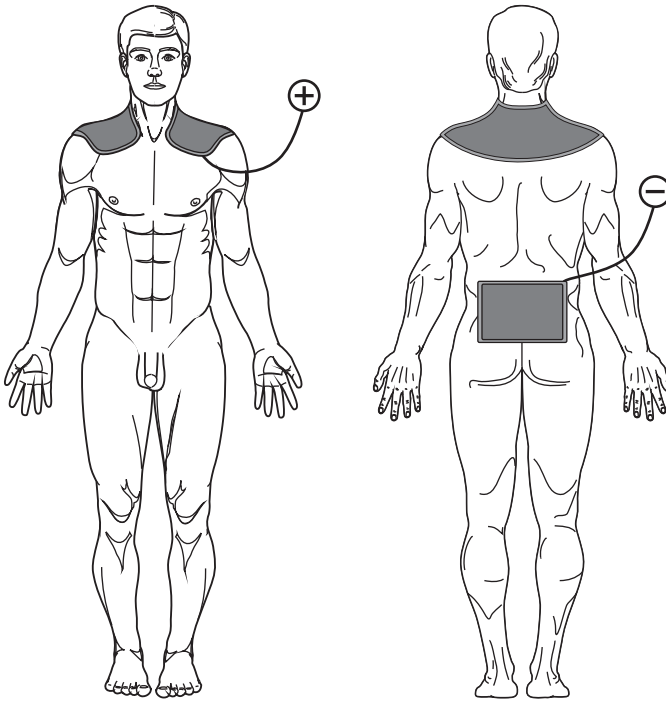

Fig. 16. Galvanic “collar” according to A.N. Shcherbak

150Hz), symmetrically on 2–6 zones (depending on the localization of the foci), for five minutes on a zone. With no side effects such severe forms of psoriasis it is possible to increase frequency up to 3000–10,000Hz.

Technique 2. Laser acupuncture (Table 4), without any comorbidity, successively on the points: GI4, GI10, P7, P5, VC14, C7, E36, RP6, F5. With the related chronic diseases, the following points are added: the points of the liver – F4, F8, F9, F13, F14; of the stomach – E2, E11, E25, E39, E43; of the kidneys – R4, R9, R10, R14, R27; with metabolic disorder – RP2, V40, F3, E39, VC13; with the endocrine diseases – V62, V39, C8, C3, C5. There are 10–12 procedures (sessions) every other day per course. [Volkov V.M., 1990].

Technique 3. Paravertebrally on zones Th_I–Th_{XII}, the technique is contact-mirror, labile, with the LO-904-20 pulsed IR laser head and the ZN-35 mirror nozzle (wavelength is 904nm, power is 10–15W, frequency

is 80–150Hz), the exposure is one minute. 10–12 procedures (sessions) per course.

Technique 4. ILBI-635. A.I. Vilshonkov et al., (1997) proved that ILBI-635 (wavelength of 635nm) with the increased power of LLLT is the most effective for patients with psoriasis arthropica. The activity of the antioxidant protection is increased, the barrier properties of erythrocyte membranes are activated, the immunomodulatory effect is provided. On the first day the power is 1–2mW, then the power is increased by 2mW every day up to 18–20mW at the last session. The total number of daily procedures is 10. The exposure of each session is 20 minutes.

Technique 5. ILBI combined [Patent 2562316 RU].

The sessions are daily, during the afternoon, for 15 days. The local exposure is carried out by a matrix emitter consisting of 8 laser diodes of the total surface area of 8cm². The wavelength is 635nm. The exposure time is two minutes per one area in pulsed contact mode. The light pulse length is 100–130ns. The pulse power is 40W at a varying frequency. ILBI is carried out by a continuous laser light at a wavelength of 525nm with varying power and exposure. The exposure conforms to the following schedule:

1st session – local: frequency 80Hz, ILBI: power 2mW, exposure 5 minutes.

2nd session – local: frequency 150Hz, ILBI: power 5mW, exposure 7 minutes.

3rd session – local: frequency 600Hz, ILBI: power 5mW, exposure 12 minutes.

4th session – local: frequency 1500Hz, ILBI: power 10mW, exposure 15 minutes.

5th session – local: frequency 3000Hz, ILBI: power 15mW, exposure 15 minutes.

6th–7th sessions – local: frequency 6000Hz, ILBI: power 15mW, exposure 20 minutes.

8th–10th sessions – local: frequency 10,000Hz, ILBI: power 20mW, exposure 20 minutes.

11th–12th sessions – local: frequency 1500Hz, ILBI: power 20mW, exposure 20 minutes.

13th–15th sessions – local: frequency 80Hz, ILBI: power 20mW, exposure 20 minutes.

EFFECT: reducing the length of psoriasis treatment, prolonging remission that is ensured by the integrated effect on different links of the disease process.

Erysipelas

Low level laser therapy, which has a positive influence on the immune system and blood rheology, is advised for the treatment of patients with erysipelas. We have shown that the combined external exposure together with ILBI allows the enhancing of tissue blood flow, restoring vascular tone and reactivity alongside the activation of cellular immunity, which, in the aggregate, makes the number of recurrences 7–8 times less [Egorov V.E. et al., 1997].

Technique 1. Combined. The patients' treatment is implemented depending on the clinical form of erysipelas. With the bullous form for much faster epithelialization the exposure is implemented at a distance, in a stable manner, with KLO-635-50 head (wavelength is 635nm, continuous mode, power is 50mW, power density is 5mW/cm² – light spot above the focus is 10–12cm²), the exposure on a zone is 1.5–2 minutes.

With erythematous and erythematous-hemorrhagic forms of erysipelas the exposure is implemented on the affected area, regional lymph vessels and lymph nodes, it is in contact with the ML-904-80 matrix pulsed IR laser head (wavelength is 904nm, maximum power is 60–80W), frequency is 1500–3000Hz in the acute stage of the disease and 80–150Hz in the period of convalescence, the exposure on a zone is 1.5–2 minutes [Egorov V.E. et al., 1997].

Technique 2. Combined. It is implemented two times a day against the background of detoxification and antibiotic therapy. NLBI is implemented on the area of the vascular bundle above the affected area in contact with and on the focus (Table 7, Fig. 17), for example, on the tibia, with the LO-904-20 pulsed IR laser head and the ZN-35 mirror nozzle (wavelength is 904nm, power is 10–15W, frequency is 80–150Hz), the exposure is distant, labile, at the distance of 0.5–1cm from the skins surface. For patients with face erysipelas laser exposure is implemented on the area of carotid arteries (zone 3) on both sides, parasternally on the right and on the left in the second intercostals space (zone 4) and on the affected area 5. In 3 weeks the course of therapy is repeated, but the procedures are implemented once a day.

With the ILBI technique (Table 5 or 6), there are 5–7 procedures (sessions) per course – additionally to technique 2 or 3.

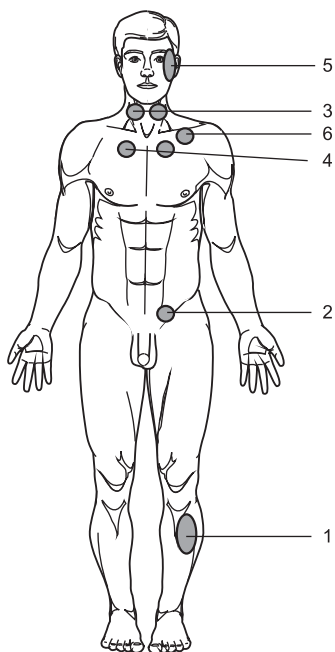

Fig. 17. Exposed zones for erysipelatous inflammation

Lyell's Syndrome

ILBI technique (Table 6), the time of the procedure for ILBI-635 is 30–60 minutes. There are 5–7 daily procedures per course [Toygabayev A.A. et al., 1989].

Eczema

In treatment of patients with eczema, ILBI leads to the reduction of the ATP heightened before the treatment, of the erythrocyte membranes, to the elimination of the tissue hypoxia and to the normalization of the activity of alkaline and acid phosphatase in the peripheral blood neutrophils [Isakov S.A., 1994].

ILBI technique (Table 6), power at the light guide end for ILBI-635 is 5.0–7.0mW, the time of the procedure is 30–60 minutes. There are 8–12 daily procedures per course [Plotnikov A.V., 1991].

Musculoskeletal Disorders

Low level laser therapy is advised in the subacute period of the disease process, the treatment is long (up to several years), the courses are 2 times a year, in the complex of therapeutic interventions. The course of treatment should be started 2 weeks before the expected exacerbation (spring – autumn) and it consists of 10–12 daily procedures. The second course can be implemented in 3 weeks. The total time of the session must not exceed 10 minutes. It is not necessary to try to expose all the affected joints during one session. It is reasonable to choose 2–3 joints disturbing the patient the most at that particular moment. The basic condition of successful treatment is the discharge and repose of the affected joint (using a cane while walking, limited mobility, immobilization).

In the treatment of the diseases of small hand and foot joints, they are exposed from the rear side in the point of maximum pain. Elbow, wrist, ankle joints are exposed from the flexion and extensor sides each. Shoulder, knee joints are exposed from three sides. Hip joints are exposed through the zone of the projection of the crural arch, trochanter and ischial tuberosity. The exposure by fields is implemented along the projection of the joint space (Fig. 18).

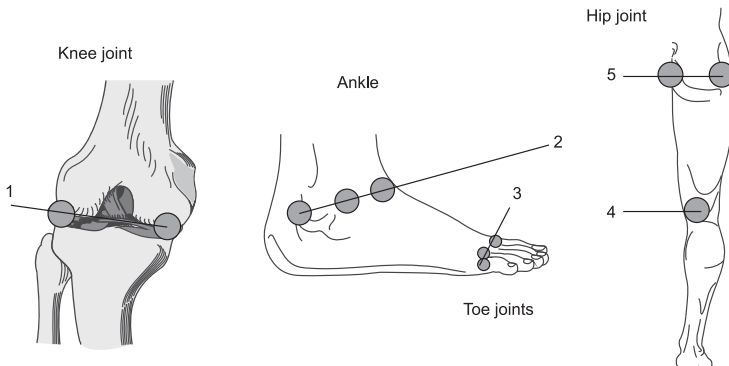

Fig. 18. Exposed zones for diseases of the joints

Osteoarthritis

The treatment is implemented alongside a healthy diet and medication.

LLLT technique is contact, stable with the LO-904-20 pulsed IR laser head and the ZM-50 magnet nozzle (wavelength is 904nm, power is 10–15W, frequency is 80–150Hz) for 1–2 minutes (for example, on fields 1 and 4 for the knee joint) (Fig. 18). Labile technique, implying the scanning with the laser light along the joint space, is also acceptable. Painful points in the joints, projections of the joint space, of the muscle and tendon seals, of the contractures, on the segmental paravertebral zones (with ZN-35 mirror nozzle) are also exposed. At the beginning of the course the exposure is implemented on 2–4 pain points, in the middle of the course (6–8th session) on 6–8 points, at the end of the course on 4–6 points.

ILBI technique (Table 5 and 6), there are 5–7 daily procedures.

Rheumatoid Arthritis

LLLT in the acute stage of the disease is combined with the limb reposition and discharge. During the first three days it is reasonable to expose with the ML-904-80 matrix pulsed IR laser head (wavelength is 904nm, maximum power is 60–80W, frequency is 3000–10,000Hz), scanning along the joint space at a distance for one minute. This is followed with the LO-904-20 pulsed IR laser head and the ZM-50 magnet nozzle (wavelength is 904nm, power is 10–15W, frequency is 80–150Hz) on zones 1 and 4 for 1.5–2 minutes (Fig. 18). Low level laser therapy is implemented together with the elimination of the nidus. With the chronic form of the disease, massage and physical therapy are also prescribed. The second course of low level laser therapy is implemented in one month.

ILBI technique (Table 5 or 6), there are 5–7 daily procedures.

Fibromyalgia

Laser exposure is brought to the affected area (pain point, trigger zone, lesion in the tissues detected by X-ray).

LLLT technique is contact, stable with the LO-904-20 pulsed IR laser head and the ZM-50 magnet nozzle (wavelength is 904nm, power is 10–15W, frequency is 80–150Hz) successively on zones 1–4 for 1.5–2 minutes (Fig. 19). The course of treatment is 10–12 daily procedures. If necessary, LLLT is repeated in 3–4 weeks. The combination of LLLT

with massage, physical and manual therapy increases the efficiency of the treatment greatly.

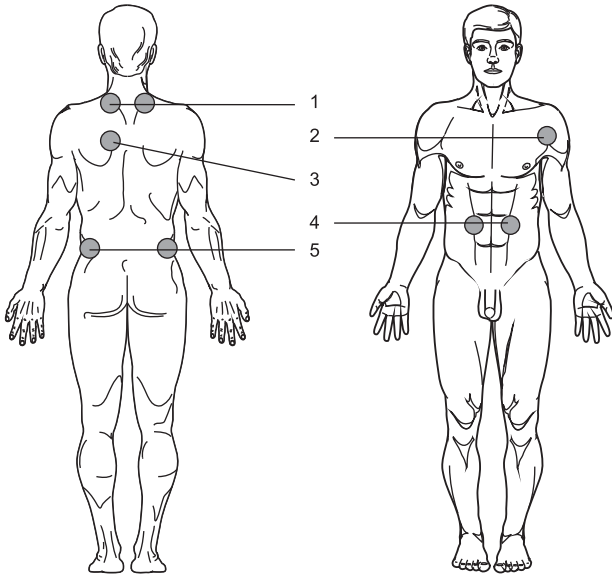

Fig. 19. Exposed zones for fibromyalgia

Epicondylitis (Enthesopathy)

During the period of treatment and for two weeks after the end of the course of therapy, the patient is advised to limit physical stress on the affected limb as much as possible.

LLLT technique is contact, stable with the LO-904-20 pulsed IR laser head and the ZM-50 magnet nozzle (wavelength is 904nm, power is 10–15W, frequency is 80–150Hz) for 1.5–2 minutes on the point of pain where the tendon is attached to the bone (Fig. 20, zone 1) moderately compressing the soft tissues. It is reasonable to apply the A-3 acupuncture nozzle, which allows an increase of the power density (PD) by several times of LLLT due to impact area minimizing and more accurate delivery of illumination to the pain point. Additionally, the C_{VII} area is exposed paravertebrally, symmetrically (Fig. 20, zone 2, contact labile technique)

and on the Th_x level (Fig. 20, zone 3, contact stable technique) symmetrically. There are up to 12 daily procedures per course. In 2–3 weeks, the course of low level laser therapy can be repeated according to this scheme, but only every other day.

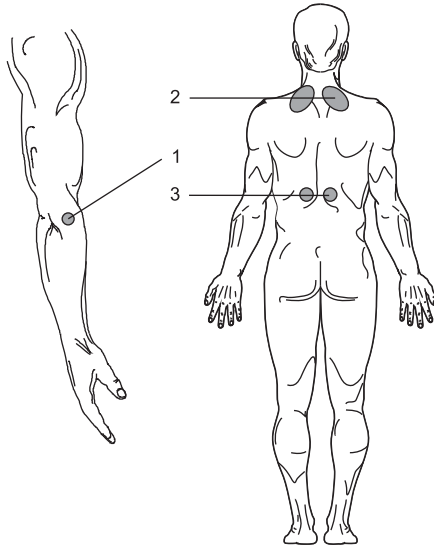

Fig. 20. Exposed zones for epicondylitis

Tendovaginitis. Myositis

In the acute stage, during the first 3 days it is reasonable to implement distant exposure (distance is 1–2cm) with the ML-904-80 matrix pulsed IR laser head (wavelength is 904nm, maximum power is 60–80W, frequency is 3000–10,000Hz), the exposure is one minute. Then with the LO-904-20 pulsed IR laser head and the ZM-50 magnet nozzle (wavelength is 904nm, power is 10–15W, frequency is 80–150Hz) for two minutes, in the zone of the affected tendon or muscle (Fig. 21, zones 1 or 3) making contact but without any compression of the soft tissues (according to labile technique) and paravertebrally (Fig. 21, zone 2), making contact, in a stable manner. The course of treatment consists of 12 daily procedures. In two weeks, the LLLT can be repeated, but the procedures are implemented only every other day.

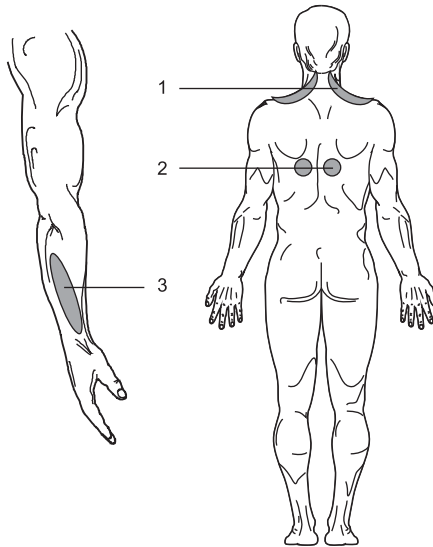

Fig. 21. Exposed zones for tendovaginitis and myositis

Heel Spurs

The LLLT technique is used contact, stable. The first 3 procedures are implemented every day for two minutes on the zone of the projection of the heel spur on the plantar surface of a foot, where the Achilles tendon is attached to the calcaneus (heel bone). From the 4th procedure, the zone on the inner or outer surface of the heel area is added (the patient often indicates the pain in this zone, the doctor finds the painful point by

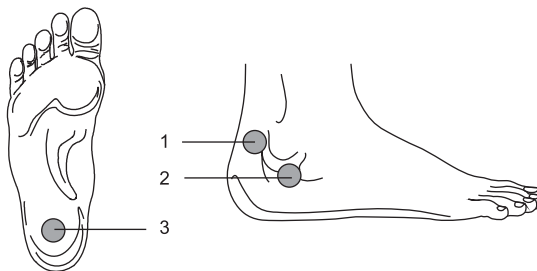

Fig. 22. Exposed zones for heel spurs

palpation. During the first 3 days it is reasonable to implement distant exposure (distance is 1cm) with the ML-904-80 matrix pulsed IR laser head (wavelength is 904nm, maximum power is 60–80W, frequency is 3000–10,000Hz), the exposure is one minute on the zone of the projection of the heel spur on the plantar surface, and then for two minutes with the LO-904-20 pulsed IR laser head and the ZN-35 mirror nozzle (wavelength is 904nm, power is 10–15W, frequency is 80–150Hz) (Fig. 22).

There are 10 procedures per course. After an interval of 2 weeks, the course consisting of 10 daily procedures with the same parameters is repeated. If necessary, in 2 weeks the 3rd course is implemented. In resistant cases the therapy can be repeated according to this scheme for 6 months.

Peripheral Vascular Disorders

Atherosclerotic Arteriopathy of the Lower Extremities

ILBI technique (Table 5 or 6), there are 7–10 daily procedures.

Additionally, to ILBI, beginning with the 3rd procedure, the exposure on the projection of the vessels of the inguinal and paravertebral area of the lumbosacral spine is implemented with the LO-904-20 pulsed IR laser emitting head and the ZN-35 mirror nozzle (wavelength is 904nm, power is 10–15W, frequency is 80–150Hz), for two minutes. There are 10 daily procedures per course.

Diabetic Angiopathy of Lower Extremities

ILBI technique (Table 5 or 6), there are 7–10 daily procedures.

Additionally to ILBI, the contact-mirror, stable technique is implemented, the exposure is along the projection of the affected vein and vascular bundles (by 4 zones), and on the area of trophic ulcer through 1–2 layers of a sterile gauze with the LO-904-20 pulsed IR laser emitting head and the ZM-50 magnet nozzle (wavelength is 904nm, power is 10–15W, frequency is 80–150Hz) on fields 1, 2, 3, 6 successively for one minute, and on fields 4, 5, 7, 8 successively for two minutes (Fig. 23).

Raynaud's Syndrome

The LLLT technique is contact, stable with the LO-904-20 pulsed IR laser head and the ZM-50 magnet nozzle (wavelength is 904nm, power

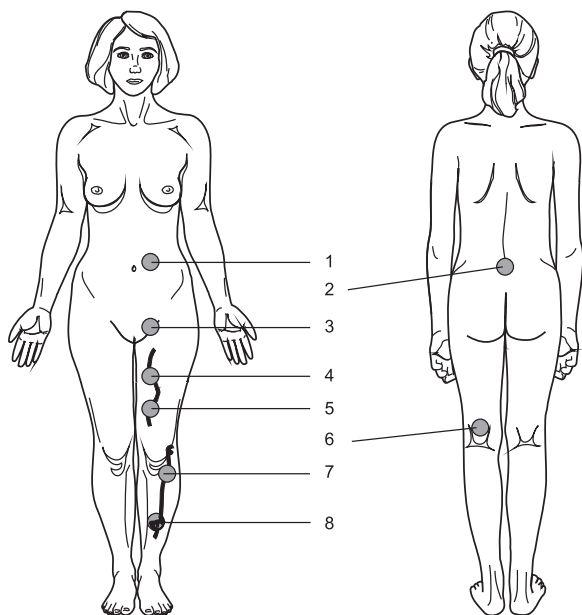

Fig. 23. Exposed zones for inflammatory diseases of the veins

is 10–15W, frequency is 80–150Hz) on zones 1–7 successively for one minute (Fig. 24).

Additionally, in one day, the distant exposure (at a distance of 1–2cm) of the tips of all the ten fingers (zone 8, Fig. 24) is implemented for 0.5 minute with the LO-635-5 pulsed laser head of the red spectrum (wavelength is 635nm, power is 5W, frequency is 80–150Hz).

Obliterating Vessel Lesions of the Extremities

The indications for the requirements of low level laser therapy are: occlusions of the terminal segment of the abdominal aorta and main arteries of the lower extremities (atherosclerotic lesions of the aorto-iliac and femoral-patellar segments, Leriche syndrome) in sub- and compensated conditions of the peripheral blood circulation, obliterating endarteritis.

The LLLT technique is contact, stable with the LO-904-20 pulsed IR laser head and the ZM-50 magnet nozzle (wavelength is 904nm, power is 10–15W, frequency is 80–150Hz) on fields 1–5 successively for 1.5–2 minutes (Fig. 25).

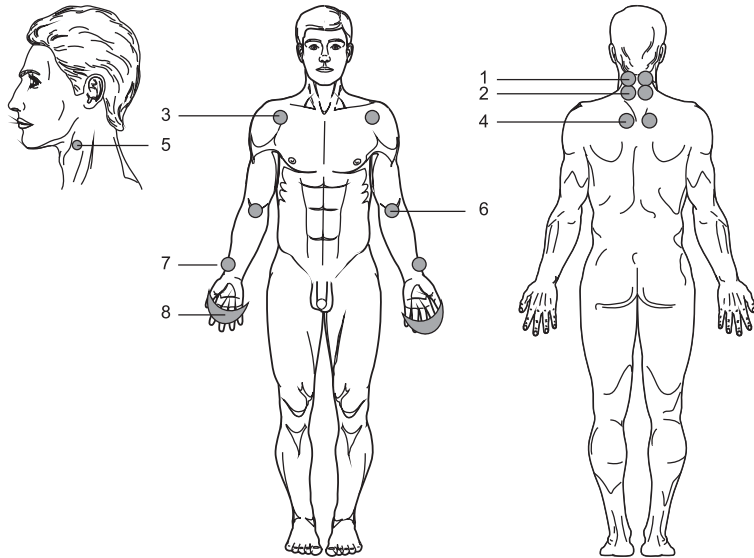

Fig. 24. Exposed zones for Raynaud's disease

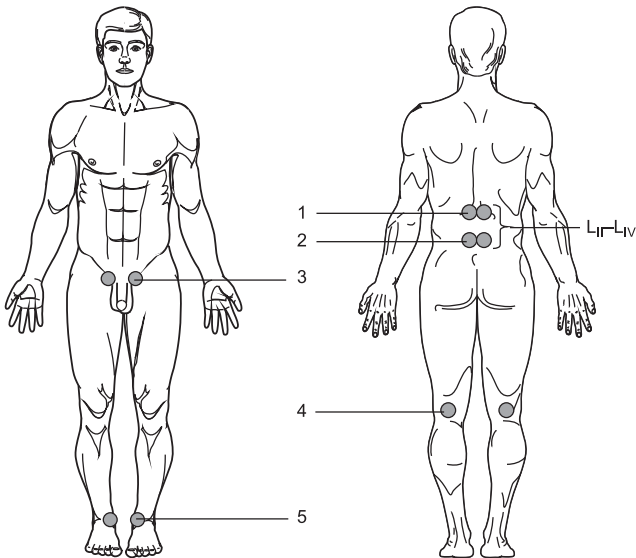

Fig. 25. Exposed zones for occlusive lesions of the lower limbs

The most obvious low level laser therapy effect is registered by the patients in the early stage of the disease (with ischemia of the lower extremities of I–II degrees). Three courses of therapy are implemented successively within a 3-week interval, followed by a 6-month break. Limb tissue ischemia of III and IV degrees is an indication for treatment in hospital.

ILBI technique (Table 5 or 6), there are 7–10 daily procedures per course.

Phlebitis, Thrombophlebitis, Postthrombophlebitic Trophic Disorders and Ulcers

LLLT is implemented alongside medication and immunity correction.

The technique used is contact, stable, the exposure is on-skin along the projection of the affected vein and vascular bundles (by 4 zones), and on the area of trophic ulcer through 1–2 layers of sterile gauze with the LO-904-20 pulsed IR laser head and the ZM-50 magnet nozzle (wavelength is 904nm, power is 10–15W, frequency is 80–150Hz) on fields 1, 2, 3, 6 successively for one minute, and on fields 4, 5, 7, 8 successively for two minutes (Fig. 23).

If there are trophic ulcers, it is advisable to alternate (every other day) the exposure with pulse IR LLLT on the zones with the exposure on the open surface of the ulcerative defect with pulse LLLT of the red spectrum with the LO-635-5 pulsed laser head (wavelength is 635nm, power is 5W, frequency is 80–150Hz). The technique is distant, stable on the points with the ulcer surface edges or scanning (depending on the ulcerative defect size). The distance between the laser head and the skin surface (ulcer surface) needs to be 2–3cm.

2–3 courses are implemented within a two-week interval (10 daily procedures per course). If necessary, the repetition of the procedures is advisable in six months after the end of the last course.

ILBI technique (Table 5 or 6), there are 7–10 daily procedures per course.

Gastrointestinal Disorders

Viral Hepatitis

As a general rule, the course of low level laser therapy consists of 10–12 daily procedures. If necessary, the number of the procedures can

be increased to up to 20, and with chronic hepatitis it is possible to implement the second course within one month, and the third course – in 3 months, and then, preventive low level laser therapy courses twice a year – in the spring and autumn.

After the end of the low level laser therapy session, a 15–20 minute repose is recommended. The procedures should be implemented at the same time, as vascular reactions and changes in the metabolism underlying the mechanisms of laser illumination effect have a phase, rhythmic in character [Makashova V.V., 2003].

ILBI technique (Table 5 or 6), there are 10–12 procedures per course every day until the patient receives a clinical and biochemical effect.

ILBI technique (Table 7) successively on zones 1, 2, 3 (Fig. 26). The exposure depends on the beginning of low level laser therapy:

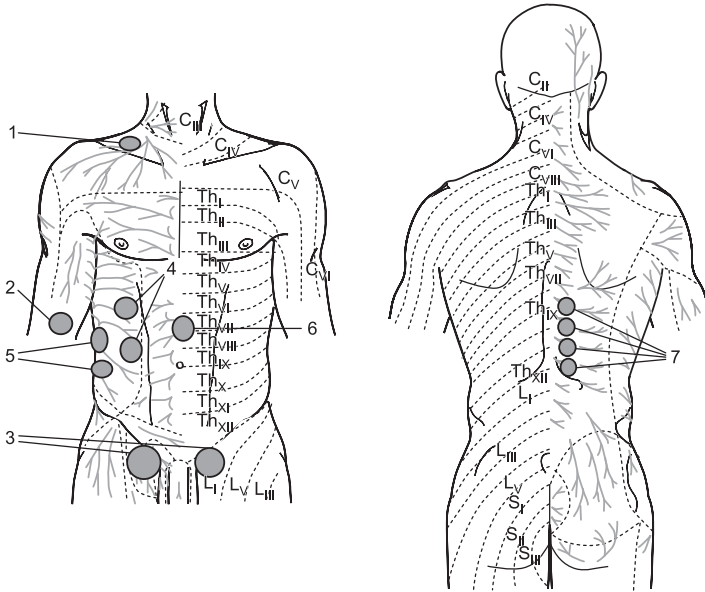

Fig. 26. Exposed zones for viral hepatitis: 1 – supraclavicular vascular bundle; 2 – cubital vascular bundle; 3 – femoral vascular bundle; 4 – along midclavicular line right on the right – VI, VII intercostal space and the lower edge of the costal arch; 5 – along middle subaxillary line on the right – VIII, IX intercostal space; 6 – midway between the xiphoid cartilage and the omphalus; 7 – along paravertebral lines at a level of IX, X, XI, XII intercostal spaces

- the acute period up to the 10th day of the icteric period: during the first 1–2 sessions 2–3 fields with the exposure are 15s on one field, further the time is increased to 30 seconds and the number of fields to 6 during 1 session, but no more. The exposure can increase up to five minutes until receiving any clinical and/or biochemical effects (generally, after 6–7 procedures) with the time further decreasing to 1–0.5 minutes (according to sinusoid).
- long cytolytic or cholestatic syndrome (the icteric period is longer than 21–35 days): to start with the maximum exposure of five minutes and maximum number of fields (6) until the patient receives clinical and/or biochemical effects with the further time and field number decreasing [Makashova V.V., 2003].

Combined technique. The external exposure on the zones is implemented. The technique is contact, stable. The exposed fields are alternated from three to six. The ML-904-80 matrix pulsed IR laser head (wavelength is 904nm, maximum power is 60–80W, frequency is 80–150Hz) is the most optimum to expose on zones 4, 5, 6 (Fig. 26), for 0.5 minute on each zone successively. The exposure on zone 7 (Fig. 26) in the Th_{IX}–Th_{XII} area is paravertebral symmetric with the LO-904-20 pulsed IR laser head and the ZM-50 magnet nozzle (wavelength is 904nm, power is 10–15W, frequency is 80–150Hz) for 0.5 minute successively [Makashova V.V., 2003].

Combined low level laser therapy technique is used with the prolonged course of acute viral hepatitis with long cytolytic or cholestatic syndrome, and also with the patients with chronic viral hepatitis in the following options [Makashova V.V., 2003]:

- ILBI-635 – 5–6 procedures every day until the patient receives a clinical effect with the further external exposure on the zones (to 12–15 procedures, with chronic hepatitis – to 20);
- ILBI-635 – 5–6 procedures every day with further laser acupuncture (to 12–15 procedures, with chronic hepatitis – to 20);
- NLBI (Table 7) 5–6 procedures every day with further external exposure on the zones (to 20 procedures with chronic hepatitis);
- NLBI (Table 7) 5–6 procedures every day with the further laser acupuncture (to 20 procedures with chronic hepatitis);
- the exposure of the neuro-vascular bundles (alternately during each session: supraclavicular, cubital, femoral, etc.) and the external

- exposure on the zones (to 12 procedures with acute viral hepatitis and to 20 procedures with chronic hepatitis);
- the exposure of the neuro-vascular bundles and laser acupuncture (12 procedures with acute and 20 – with chronic hepatitis).

Gastritis, Duodenitis, Dyskinesia of the Digestive Organs

Low level laser therapy eliminates the motor-tonic disorders of the stomach and the duodenum, which contribute to biliary dyskinesia, and allow the colloidal bile to restore stability, restores the portal-hepatic blood flow, allows the normalization of chologenic liver function, eliminates cholestatic syndrome, which contributes to the prevention of the transformation of pure functional disorders of the biliary system into organic pathology [Salova L.M., 1991].

Low level laser therapy is implemented according to techniques 1, 3, 5 on the section of the “Gastroduodenal ulcer” and on the zones shown in Fig. 27.

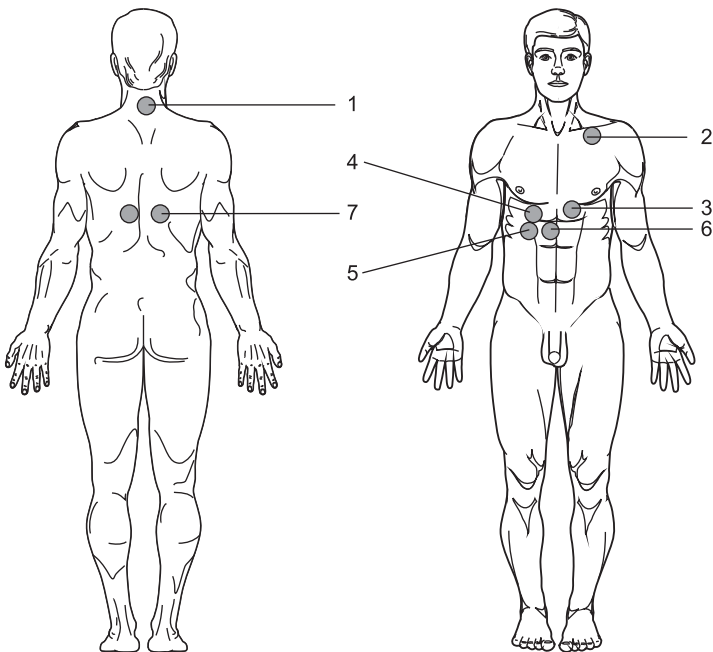

Fig. 27. Exposed zones for gastroduodenal ulcer

Obstructive Jaundice

ILBI technique (Table 5 or 6), there are 3–5 daily procedures per course.

Acute Intestinal Obstruction

ILBI technique (Table 5 or 6), there are 3–5 daily procedures per course.

Acute and Chronic Cholecystitis

Low level laser therapy is implemented alongside a healthy diet and medication. The technique is stable on zones 1, 2, 4, 3 (Fig. 28) with the ML-904-80 matrix pulsed IR laser head (wavelength is 904nm, maximum power is 60–80W, frequency is 80–150Hz), for 1.5–2 minutes on a zone, there are 10–12 daily procedures per course.

With back pain, additionally, the zones in the Th_{VII}–Th_{XI} area (the localization of these zones is defined by the doctor by palpation) are exposed paravertebrally, symmetrically for one minute. The procedures should be implemented in the morning (from 9 to 11 a.m.). In 3–4 weeks the second course is implemented (10–12 daily procedures).

ILBI technique (Table 5 or 6), there are 2 daily procedures in the preoperative period and 3–5 in the postoperative period per course.

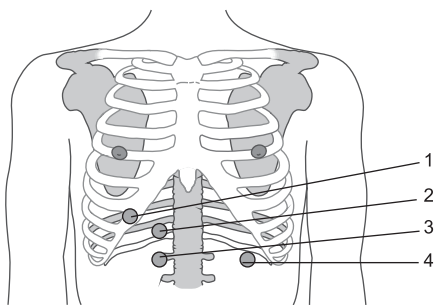

Fig. 28. Exposed zones for chronic cholecystitis and pancreatitis

Intoxication

After ILBI the rheological parameters of blood are improved, the pronounced disaggregating effect is shown, which contributes to quicker

relief of erythrocyte aggregation disorders, typical for severe intoxications, and eliminates the microcirculation and hemodynamic disorders of patients with severe intoxication [Zazulevskaya L.Y. et al., 1989].

ILBI technique (Table 5 or 6), there are 3–5 daily procedures per course.

Chronic Pancreatitis

ILBI technique (Table 5 or 6), there are 5–10 daily procedures per course.

Acute Pancreatitis

ILBI in the complex treatment of patients with acute pancreatitis allows health improvement of 75–80% of patients after a single session. Pain disappears, a tendency for the normalization of the activity of pancreatic enzymes comes quicker. The maximum therapeutic effect is observed in the patients with the edematous form of acute pancreatitis, as well as with the destructive forms of acute pancreatitis (fat and hemorrhagic pancreatic necrosis). Rapid disappearance of transaminase from blood serum in patients with acute pancreatitis indicates that ILBI contributes to the prevention of the destructive process in the pancreas.

Low level laser therapy is implemented alongside a healthy diet and medication. The technique is contact, stable on zones 4, 3, 2, 1 (Fig. 28) with the ML-904-80 matrix pulsed IR laser head (wavelength is 904nm, maximum power is 60–80W), for 1.5–2 minutes on a single zone. There are 10–12 daily procedures per course, the first 1–2 procedures have a frequency of 3000–10,000Hz (analgesic effect), and the rest of the procedures have a frequency of 80–150Hz.

Additionally, with back pain, the zones in the Th_{VII}–Th_{XI} area (the localization of these zones is defined by the doctor by palpation) are exposed paravertebrally, symmetrically for one minute. The procedures should be implemented in the morning (from 9 to 11 a.m.). In 3–4 weeks, the second course is implemented (10–12 daily procedures).

ILBI technique (Table 5 or 6), there are 5–8 daily procedures per course.

Hepatic Insufficiency

ILBI technique (Table 5 or 6), there are 3–5 daily procedures per course.

Chronic Hepatitis

Low level laser therapy is implemented alongside a healthy diet and medication. The technique is contact, stable on the liver area, successively on zones 4 (Fig. 26) with the ML-904-80 matrix pulsed IR laser head (wavelength is 904nm, maximum power is 60–80W), for 1.5–2 minutes on a zone, there are 10–12 daily procedures per course. The second course is implemented in one month.

Chronic Nonulcerative Colitis

ILBI-635 technique (Table 6), there are 5–7 procedures per course, every other day. For ulcerative colitis V.M. Petushinova (1993) recommends increasing the exposure up to 30 minutes.

Hepatic Cirrhosis

In the treatment of patients with hepatic cirrhosis LLLT, according to the data of functional and morphological observations, in particular can cause changes indicating a tendency to cirrhotic process regress, at the stages of preoperative preparation and postoperative care of patients, LLLT allows the decreasing of the number and severity of postoperative complications (hepatic insufficiency, suppuration of wounds, etc.). At the stage of conservative treatment, laser exposure allows the reduction of the activity of transaminases, enhancing the functional activity of hepatocytes and stimulating intrahepatic blood flow [Artykov Sh.N., 1992].

Low level laser therapy is implemented alongside a healthy diet and traditional medication, and alcohol is strictly forbidden.

Contact stable technique is implemented on the area of the liver projection from three sides (along the parasternal, midclavicular and anterior axillary lines) with a moderate compression of tissues with the ML-904-80 matrix pulsed IR laser head (wavelength is 904nm, maximum power is 60–80W, frequency is 80–150Hz), for 1.5–2 minutes on a zone. With resistant ascites, the exposure is implemented through the intercostal spaces in the right half of the chest on the liver projection along middle axillary and midclavicular lines. In the postoperative period, in addition, the wound is exposed through a bandage, with splenectomy the area of the projection of the spleen is exposed. The total number of procedures per course is from 5 to 20 [Artykov Sh.N., 1992].

ILBI technique (Table 5 or 6), there are 10–12 daily procedures per course. For patients with hepatic cirrhosis at the stage of decompensation,

with the manifestations of splenomegaly, hypersplenism, with resistant ascites, the application of only the ILBI-635 is not effective enough [Varivoda E.S., 1990].

Gastroduodenal Ulcer

Low level laser therapy is implemented alongside a standard medication scheme. The possibility for the significant reduction of the number of dosage forms and their dosage during low level laser therapy allows the consideration for LLLT to be an active therapeutic factor, potentiating the medication effect [Zakharov P.I., Moskvina S.V., 2007; Zakharov P.I. et al., 2005].

If the symptoms of the gastroduodenal ulcer (GU) are not severe, low level laser therapy is the main and only method of treatment alongside a healthy diet and an organized sleep pattern (it is necessary to achieve full uninterrupted sleep for up to 7–9 hours). The treatment is outpatient, if necessary, in hospital. In some cases, we observed the healing of the ulcer after the 4–5th low level laser therapy procedure, however, generally it happens by the 10–12th procedure. The positive dynamics of clinical symptoms is often observed after the 1–2nd procedure (with the additional exposure on the particular acupuncture points).

Preventive courses of low level laser therapy are recommended twice a year (spring and autumn), 5–10 daily procedures per course. Our research showed that the non-recurrent period with all the patients can continue for up to 10 years and longer [Zakharov P.I. et al., 2005; Moskvina S.V., Zakharov P.I., 2013].

Technique 1. Contact, stable. Laser exposure is implemented on pain zones in the epigastric region, on the back in the Th_X–Th_{XII} area paravertebrally (defined by palpation), symmetrically, successively on zones 2, 4, 6, 7 (Fig. 27) with the ML-904-80 matrix pulsed IR laser head and the MM-50 magnet nozzle (wavelength is 904nm, maximum power is 60–80W, frequency is 80–150Hz), for 1.5–2 minutes on a zone, and there are 10–12 procedures per course. In 2 weeks the course of low level laser therapy is repeated, if necessary (no result), (10–12 daily procedures).

Technique 2. LLLT modulation mode with a patient's biorhythms ("BIO"). Low level laser therapy and acupuncture in the periods of magnetic storms and seasonal exacerbations (it is reasonable to start treatment a bit earlier than the expected natural disturbances occur) according to

the mentioned techniques can considerably facilitate the clinical manifestations of the disease and accelerate the recovery. “Biosynchronized” low level laser therapy (with “Matrix-BIO” device) is very physiologic (taking into consideration the above mentioned).

It is reasonable to apply two laser heads at the same time – the IR pulsed matrix (ML-904-80 with PMN nozzle, wavelength is 904nm, maximum power is 60–80W, frequency is 3000Hz) and the IR pulsed with one laser diode (LO-904-20 with the ZN-35 mirror nozzle, wavelength is 904nm, maximum power is 15–20W, frequency is 3000Hz). The Matrix laser head is used to expose large zones (epigastric region, back muscles, clavicle). There are pulse and respiration sensors on a patient’s body, their work is checked, the exposure of 10 minutes is set on the device. The peculiarity of the technique is that the doctor must implement the procedure by himself, moving the heads along zones 1, 2, 3, 4, 5, 6, 7 (Fig. 27), without lifting them from the surface of the body. The exposure on each pair of zones is two minutes.

Technique 3. ILBI (Table 5 or 6), there are 5 to 10 procedures per course, every other day.

Cardiology

Hypertension

Low level laser therapy is advised for different functional psychosomatic disorders, accompanied by the instability of the reactions of the cardiovascular system, dyskinesia, pain syndrome; borderline hypertension, hypertension of the I–II degree; inflammatory and degenerative-dystrophic processes in the organs and tissues.

Contraindications: severe course of the cardiovascular system diseases: irregular heartbeat, atherosclerotic cardiosclerosis with severe coronary circulation disorders, cerebral sclerosis with cerebral circulation disorders, aortic aneurysm, circulatory insufficiency of the II–III degree, subacute and rehabilitation period of myocardial infarction, or post-infarction angina.

Taking into consideration the chronobiological peculiarity of the disease, presence of circadian variation of blood pressure (BP), low level laser therapy should be implemented in the morning (before 12:00 pm). Preventive courses are implemented in spring and autumn alongside medication.

Technique 1. In Fig. 29a the main exposure zones for hypertension are shown: 1 – the projection of the liver and in the left upper quadrant along nipple line – of the pancreas, 3 – the projection of the thymus, 2 – the C_I–Th_{XII} paravertebral area (symmetrically), 4 – the projection of the left subclavian vascular bundle. The technique is contact-mirror, stable with small compression of soft tissues with two LO-904-20 pulsed laser heads and the ZN-35 mirror nozzle simultaneously (wavelength is 904nm, maximum power is 15–20W), the exposure and frequency for different procedures are given in Table 9. Along these lines, 2 laser heads are slowly (2cm per 1s) being moved from the occipital tuberosities to the lower angles of the scapulae (the distance from the body surface is 1–2cm). If there is one emitting head, these lines are processed successively – first, on the left, then on the right (for one minute on each line), if there are two heads, the exposure is simultaneous for one minute. After the end of the exposure on a line (the lower scapula angle), the laser head is quickly and smoothly moved to the initial point of a line again (during this movement the illumination is directed downwards at an acute angle to the surface of the back) and then is slowly moved downwards again perpendicularly to the body.

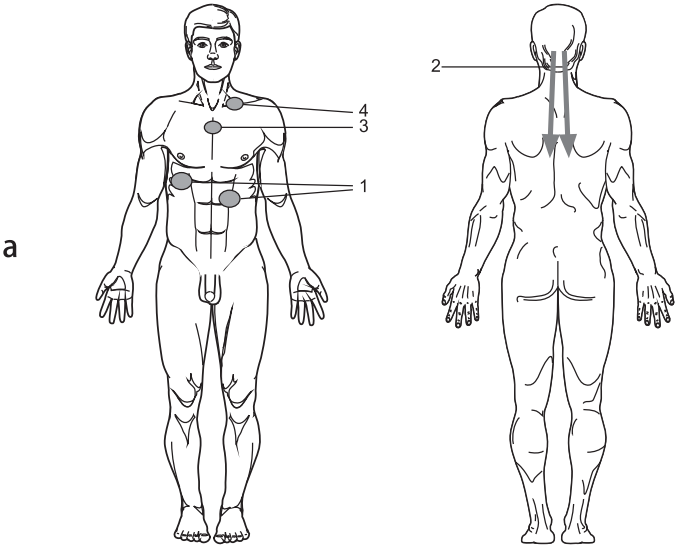

Fig. 29a. Exposed zones for hypertension

In Table 9 the low level laser therapy scheme is given, which should be followed while treating patients with arterial hypertension (AH), if they undergo the procedures for the first time. Furthermore, when the patient's reactions are known, the doctor can vary the parameters of laser exposure (can increase the frequency up to 1500–3000Hz) during the second course. The total time of the procedure must not exceed six minutes

Table 9

Low level laser therapy approximate scheme for the treatment of arterial hypertension

N_o of procedure	N_o of exposed zone	Exposure on one zone, minutes	Pulse repetition frequency, Hz
1	1, 3, 4 2	2 1	80 80
2	the same as in procedure 1		
3	1, 3, 4	2	80
4	1, 3, 4	2	80
5	1, 3, 4 2	2 3	80 80
6	the same as in procedure 5		
7	1, 3, 4 2	1 4	80 80
8	the same as in procedure 7		
9	1, 3, 4 2	2 2	80 80
10	the same as in procedure 9		
11	1, 3, 4 2	1 2	80 80
12	the same as in procedure 11		

It is necessary to pay attention to the fact, that after 2–3 procedures the patients bear high BP much easier, that is why, the doctor must focus not on the subjective evaluations of the patient, but on objective blood pressure (BP) before and after the procedure. Though the positive effect of the complex therapy of patients with hypertension is connected with BP decrease, it must not be the end in itself. The principle of the combined approach to the treatment of this category of patients implies the influence on the main links of pathogenesis together with the influence on many particular manifestations of the disease, on which the prognosis often depends. First of all this means coronary and cardiac insufficiency,

cerebral circulation disorder, atherosclerotic lesions of various vascular basins and osteochondrosis.

Technique 2. First, the exposure with ML-904-80 matrix pulsed IR laser head (wavelength is 904nm, maximum power is 60–80W, frequency is 80–150Hz) is implemented at a distance of 4–5cm from the body in a slow motion (as if the thread of a web is being pulled): along the paravertebral lines (Fig. 29b, on the right, zone 1) twice – first, on the right, then, on the left, then again on the right, and again on the left (at the end of the trajectory the device is switched off, then switched on again at the initial point). Along lines 2 (Fig. 29b, on the left) on the front surface of the body the scanning is implemented once from each side – first, on the left, then, on the right (at the end of the mechanical trajectory the device is brought outside the hand). It takes 12–15s for each line (a single pass). BP decreases immediately after the end of the exposure, the systolic is 20–30mmHg less (systolic BP), diastolic BP is 5–7mmHg less or 2–4mmHg more. If BP does not decrease, the treatment is implemented according to technique 1 (3–5 procedures), then the efficiency of technique 2 is checked again, which is the test of the efficiency of laser treatment. If the second test is negative, the treatment is focused on

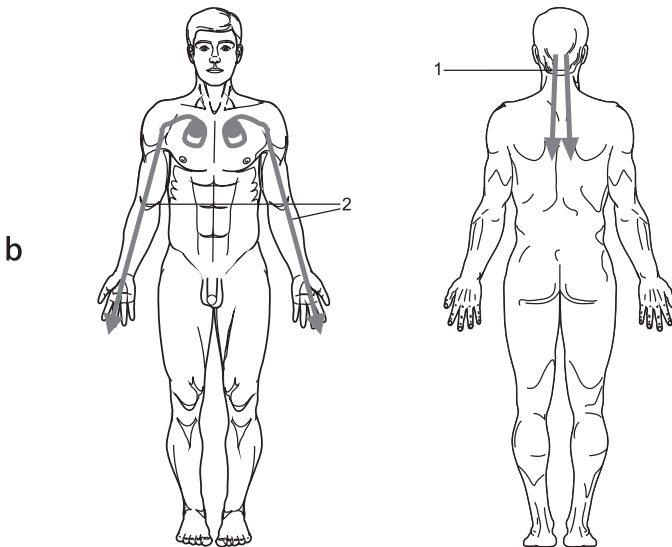

Fig. 29b. Exposed zones for hypertension

medication, and low level laser therapy is implemented in a month after the end of the main course.

Low level laser therapy efficiency depends on the stage of arterial hypertension (AH). A significant BP decrease to a normal value is chiefly observed with the patients with mild and moderate AH. A satisfactory result of the treatment with the improvement of the general condition and systolic BP drop of 30–40mmHg and diastolic BP drop of 10–15mmHg is mainly observed with patients in the severe stage of AH. The general somatic condition of most of these patients is improved together with the reduced need for antihypertensive drugs, for some patients it is possible to stop medication during the first course of low level laser therapy. Low level laser therapy for mild AH without medication is effective enough. In complex treatment of severe and malignant essential AH low level laser therapy allows considerable improving of the status indicators of various systems of the body and the quality of life.

With the ILBI-635 including in the complex therapy of patients with ischemic heart disease (IHD) and hypertonic disease, according to Ruvutskiy E.L. et al. data (1989), the obvious clinical effect is observed, the medication efficiency is increased, the hemorheological indicators are improved. Thus, blood viscosity is 30% less, aggregation of platelets is 25% less, fibrinogen is 20% less, which leads to the statistically significant reduction of the total peripheral resistance by 35%, and to diastolic BP normalization. An antiaggregatory effect was achieved by the inactivation of the products of intravascular aggregation and the improvement of the deformability of erythrocyte membranes. It is necessary to state, that the improvements of the basic parameters of hemodynamics and hemorheology are retained for 6 months after the complex treatment.

ILBI technique (Table 5 or 6), there are 3–5 procedures per course, every other day.

Myocardial Infarction (Acute Period)

With acute myocardial infarction after 1–2 procedures the pain syndrome usually disappears, the number of extrasystoles reduces and cardiac arrhythmia disappears [Toygabayev A.A. et al., 1989]. After one session of ILBI-635 in the acute period of myocardial infarction, the size of the lesion, according to ECG data, decreases by more than 33%, while in the control group there was only a 2.3% decrease, where only traditional therapy was used – 2–3% [Yerofeyev A.V. et al., 1985].

ILBI-635 technique (Table 6), there are 5–7 procedures per course, every other day.

Infectious-Allergic Myocarditis

ILBI contributes to the improvement of the indicators of phospholipid metabolism during the first 24 hours after the exposure, and by the 15th day, a total normalization of the state of the cell membranes occur [Islamkulova L.B., 1992].

ILBI technique (Table 5 or 6), there are 5–7 daily procedures per course.

Ischemic Heart Disease, Cardiac Angina

ILBI is extremely effective in treatment of patients with cardiac angina of II–IV and ischemic heart disease (IHD) that is complicated by insufficient blood supply. Hemodynamics at rest is improved as well as under isometric exercise conditions, stress tolerance is increased and the objective condition of patients is improved (health, sleep, mood) [Borisova A.V., 1997]. According to T.M. Zinkovskaya's data (1995), the most optimum combination is of IR pulse LLLT local exposure and ILBI-635.

ILBI contributes to the improvement of the cardiovascular system activity due to the slowing of the heart rate frequency, the increase of autoregulation and the degree of centralization of heart rate control [Babushkina G.V., Kartelishvili A.V., 2003; Kononov Ye.P. et al., 1989], which is often a consequence of the stress-limiting LLLT effect with IHD [Barbarash O.L. 1996]. The efficiency of ILBI considerably depends upon the initial state of pro- and anti-stress systems, which should be taken into account while varying the parameters of the technique and prescribing antioxidants [Martsiyash A.A., 1996].

The technique is contact stable with the ML-904-80 matrix pulsed IR laser head (wavelength is 904nm, maximum power is 60–80W, frequency is 80–150Hz), on zones 1–6 successively, for 1.5–2 minutes on each zone (Fig. 30).

ILBI technique (Table 5 or 6), there are 5–7 procedures per course, every day or every other day.

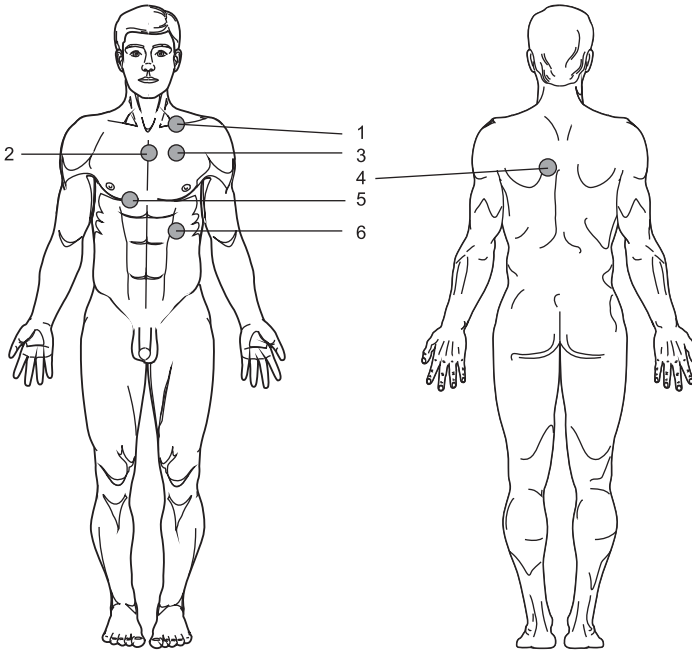

Fig. 30. Exposed zones for ischemic heart disease and angina: 1 – the projection area of the left subclavian vascular bundle; 2 – the middle third of the sternum; 3 – III rib on the left, painful point along middle clavian line; 4 – the area near the inner edge of the lower third of the left scapula; 5 – the lower ribs on the right along middle clavian line (projection of the liver); 6 – under the costal arch on the left along middle clavian line (projection of the pancreas)

Acute Coronary Insufficiency

After the implementation of ILBI for patients with acute coronary insufficiency, a significant increase of stress tolerance is observed, as well as the improvement of the parameters of Holter monitoring of the ECG (of total duration of myocardial ischemia in 24 hours, of the duration of painful and painless ischemia), positive changes of the parameters of lipid metabolism occur (the level of total cholesterol and triglycerides is decreased) and cholesterol in low density lipoproteins is normalized. Taking into consideration the importance of immune status disorder with progressive angina, it is necessary to draw attention to the fact that after ILBI the immune parameters are characterized with the favourable dy-

namics – the number of complexes influencing vessels decrease [Malinovskaya P.E. et al., 1989].

ILBI technique (Table 5 or 6), there are 5–7 daily procedures per course.

Paroxysmal Atrial Fibrillation

Contact stable technique with the ML-904-80 matrix pulsed IR laser head (wavelength is 904nm, maximum power is 60–80W, frequency is 80–150Hz), on points one symmetrically for 0.5 minute, on fields 2–5 successively for 1.5–2 minutes (Fig. 31).

The interval between the courses of low level laser therapy is 3–4 weeks.

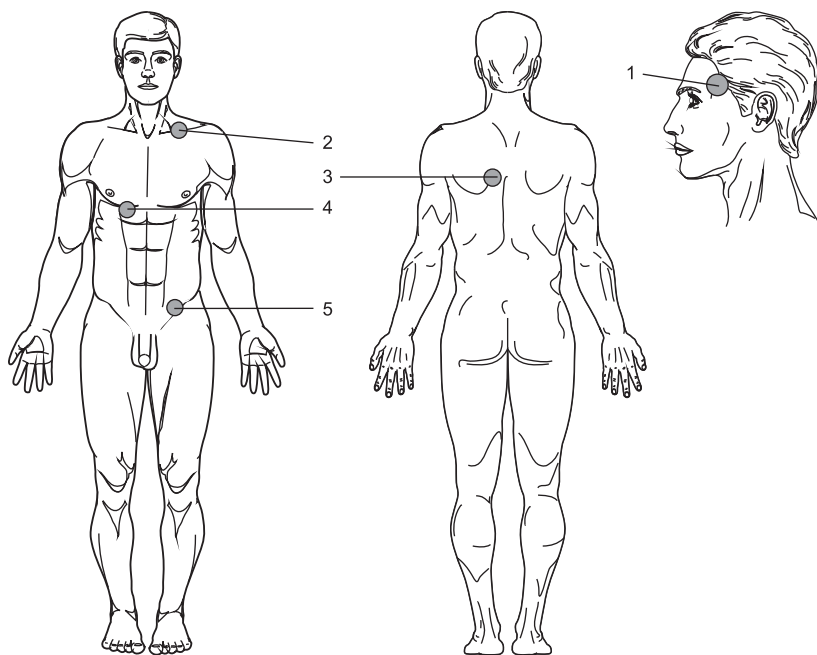

Fig. 31. Exposed zones for atrial fibrillation

Heart Defects

ILBI technique (Table 5 or 6), there are 5–7 daily procedures per course.

Sinus Dysfunction Syndrome

ILBI technique (Table 5 or 6), there are 5–7 daily procedures per course.

Neurology

Vibration Disease

ILBI technique (Table 5 or 6), there are 8–10 daily procedures per course.

Hypothalamic Syndromes

ILBI technique (Table 5 or 6), there are 12–20 procedures per course, every day or every other day.

Additionally, with the help of the LO-904-20 pulsed IR laser head with ZN-35 mirror nozzle (wavelength is 904nm, power is 10–15W, frequency is 80 and 1500Hz), the exposure is 15–30s, alternately, on each area on the following regions: the area of major neuro-vascular bundles on both sides of the neck, the anterior temporal and orbital regions, the 7th cervical vertebra (C7), the projection of the thymus and adrenal glands.

Headaches

Tension Headache

Routine examination includes a clinical examination by a neurologist, an ophthalmologist, an otorhinolaryngologist and a chiropractor, analysis of the results of the functional X-ray examination of the cervical spine and the assessment of a patient's depression level. That helps to diagnose the presence of the factor of musculo-articular dysfunction, hidden depression and ENT diseases, indications and contraindications for conjoined low level laser therapy. The algorithm of the initial manual examination of the cervical spine is supposed to meet the guidelines [Low-intensity laser physiotherapy..., 1997].

Technique 1. Combined. Low level laser therapy is implemented in the prone position with the rotated head. Each procedure includes all the

three components of the technique. The LO-904-20 pulsed laser head with ZN-35 mirror nozzle (wavelength is 904nm, power is 10–15W, frequency is 1500–3000Hz, exposure is 1.5–2 minutes on each zone), successively (Fig. 32):

- 1, the lower oblique muscle, occipital nerve, vertebral artery, intervertebral joint C₁–C₂ with ligamentous apparatus are in the zone of illumination;
- 2, located 1.5cm caudal to the mastoid ending, the sternoclavicular-mastoid muscle, suboccipital short oblique and straight muscles, vertebral artery with posterior occipital membrane, atlanto-occipital joint with ligamentous apparatus are in the zone of illumination;
- 3, the suboccipital short straight muscles, posterior occipital membrane and the ligamentous apparatus is in the zone of illumination.

Then the exposure on the projection of the common carotid artery symmetrically with the ML-635-40 matrix pulsed head of red spectrum with PMN nozzle (wavelength is 635nm, maximum power is 40W, frequency is 80–150Hz), also for 1.5–2 minutes on a zone.

The recommended course of treatment is 6–8 procedures every other day.

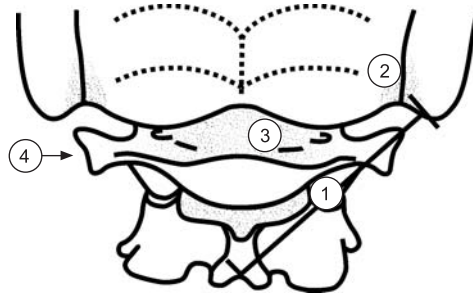

Fig. 32. The localization of diagnostic points and exposure zones for tension headaches: 1 – the middle of the line connecting the spinous process C₂ with the caudal part of the mastoid process, 2 – point located latero-cranially to caudal part of the mastoid notch, between the attachment *mm. splenius capitis et obliquus capitis superior*, 3 – point between the arch of the atlas and the occipital bone, in the depression between the trapezius and sternoclavicular-mastoid muscles, 4 – point over the transverse process C₁

Technique 2. Laser acupuncture (Table 4). First, the basic recipe (Fig. 11), then on AP55, AP34, AP22 auricular points. Additionally, judging by a patient's condition at the moment, it is possible to expose the following points: VG20, V18, RP9, V60, V20, F2, VB5, VB43, R3, E8, V7, V10, E40, VB20, VG19, IG3, VC6, V2, VG23, V23.

Cluster Headache

The basic low level laser therapy technique is similar to the tension headache treatment technique (See above). Additionally, every day the exposure with the ML-904-80 matrix pulsed IR laser head with a MM-50 magnet nozzle is implemented (wavelength is 904nm, maximum power is 60–80W, frequency is 80–150Hz), on the projection of the liver and pancreas for two minutes on each area. If there is pain in the temples, it is necessary to collect anamnesis for the stomach diseases additionally and expose painful areas in the epigastric region for 1.5–2 minutes with similar parameters.

Migraine

The headache is of the meningeal origin, and is predominantly due to the dilation of the external carotid artery branches. Trappings of this vasodilation are tension and increased pulsation of the superficial temporal artery, conjunctival hyperemia and swelling of nasal mucosa on the side of cephalgia. An almost invariable positive effect of vasoconstrictors (ergotamine) testifies in favor of vasodilation as the cause of the headache. An essential role in migraine pathogenesis has serotonin metabolism disorder, which is confirmed by the excessive urinary excretion of 5-hydroxyindoleacetic acid – a product of serotonin metabolism after a migraine attack. Coincidence of migraine attacks of some patients with the menstrual period indicates the significance of hormonal disorders and, probably fluid retention [Khodos Kh.-B.G., 2002].

Combined LLLT technique. First with ML-904-80 matrix pulsed IR laser head (wavelength is 904nm, maximum power is 60–80W, frequency is 80–150Hz), on the area of the gallbladder and the cecum – two minutes. Then, scanning with the KLO-635-15 laser head (wavelength is 635nm, continuous mode, maximum power is 10–15mW) paravertebrally on C₁–Th₁ area for 7–10 minutes. Then laser acupuncture is implemented (Table 4) on tender (a-shi) and “specific” points: E9, E36, T4, T14, V10, MC6, P7, AP55, AP34, AP22.

Degenerative-Dystrophic Spine Disorders

5–10 minutes after the end of LLLT is the most reasonable time for a session of manual therapy.

With *Cramp syndrome* the exposure is implemented, taking into account the three components of pathogenesis – the cerebral, the humoral and the reflex. Reflex reactions occur in response to an osteofibrosis phenomenon in the popliteal fossa, that is why the laser illumination is implemented on thickening portions in this zone (the triceps surae muscle attachment area) for 0.5 minute on a thickening. The impact on the cerebral symptoms is implemented by the scanning of the collar zone (at a distance of 2–3cm from a body) for one minute. Additionally, the exposure of the blood vessels in the groin area and the popliteal fossa is implemented (NLBI, Table 7, wavelength is 635nm, for two minutes on each zone).

LLLT technique is contact, stable with the ML-904-80 matrix pulsed IR laser head and the MM-50 magnet nozzle (wavelength is 904nm, maximum power is 60–80W, frequency is 80–150Hz). During the first 3 procedures the exposure is successive on zones 1–3, and beginning with the 4th to the 12th sessions the exposure is on zones 1–4 (Fig. 33).

With *restless legs syndrome* there is often masked depression. Restless legs and nocturnal myoclonus syndromes are related to the pre-sleep period, that is why it is advisable to prescribe sedatives to a patient before sleep.

Laser illumination is implemented on the lumbosacral region, the collar zone, the liver area and the region of the pancreas (Fig. 33). The technique is contact, stable with the ML-904-80 matrix pulsed IR laser head and the MM-50 magnet nozzle (wavelength is 904nm, maximum power is 60–80W, frequency is 80–150Hz), for two minutes successively from zone 1 to 4. ILBI is implemented additionally.

With *radicular syndromes* the exposure is directed at the vertebral focus in the corresponding region of the spine and the paravertebral zones, and at the dyscirculatory phenomena in the compressed root. The technique is contact, stable with the ML-904-80 matrix pulsed IR laser head and the MM-50 magnet nozzle (wavelength is 904nm, maximum power is 60–80W, frequency is 80–150Hz), for two minutes successively, on zones 1 to 4 (Fig. 34).

ILBI technique (Table 5 or 6), there are 5–6 daily procedures per course.

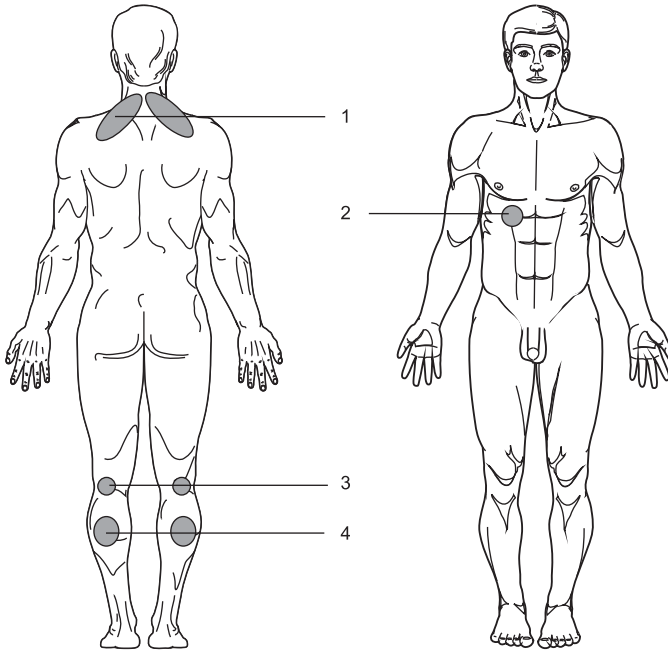

Fig. 33. Exposed zones for Cramp syndrome

Low level laser therapy must be implemented as a part of the complex treatment in close cooperation with a neuropathist and a chiropractor.

With *muscle-compression (tunnel) syndromes* A.A. Dochiya and A.V. Kartelishev (2002) recommend the combination with the external exposure by pulsed IR LILI.

ILBI technique (Table 5 or 6), there are 5–6 daily procedures per course.

External LLLT technique.

1. Paravertebrally on the affected vertebral-motor segment with the ML-904-80 matrix pulsed IR laser head and the MM-50 magnet nozzle (wavelength is 904nm, maximum power is 60–80W, frequency is 80–150Hz), the exposure is for one minute.

2. On the affected anterior scalene muscle and pectoralis minor (active trigger points), the technique is contact-mirror with the LO-904-20 pulsed IR laser head and the ZN-35 mirror nozzle (wavelength is 904nm, power is 10–15W), with a different pulse repetition frequency at each procedure

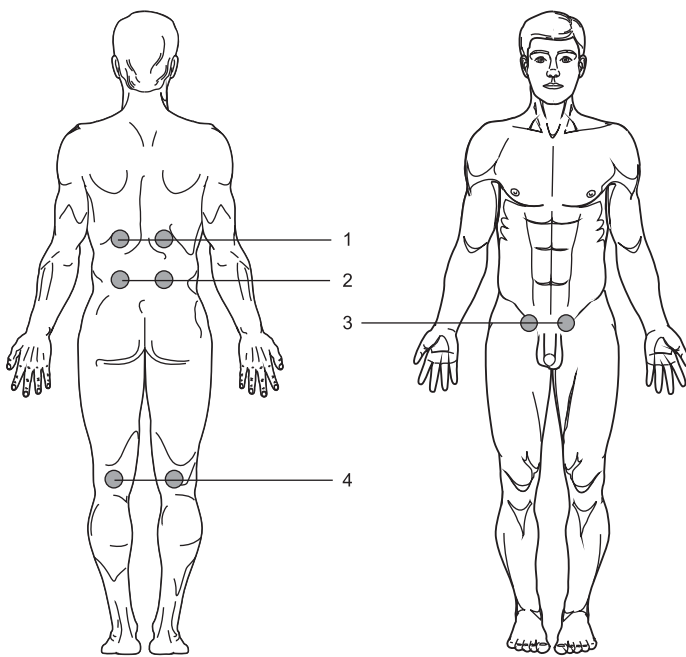

Fig. 34. Exposed zones for radicular syndrome (lumbosacral section)

(1st day – 80Hz, 2nd – 150Hz, 3rd – 300Hz, 4th – 600Hz, 5th – 1500Hz, 6th – 3000Hz, 7th – 1500Hz, 8th – 600Hz, 9th – 300Hz, 10th – 150Hz, 11th – 80Hz). The exposure depends on the location of the corresponding active myofascial trigger point of the muscle and it is 1–2 minutes for the anterior scalene muscle, and it is 2–4 minutes for the pectoralis minor.

With *cervicocranialgia* (posterior cervical sympathetic syndrome, or cervical migraine), the pain occurs in the cervico-occipital region with the illumination (more often one-sided) in the head, the headache is pulsating, the pain is made worse by the head turn and tilt, by the neck extension.

Laser acupuncture (Table 4). The choice of points depends on the localization of the maximum pain. If the maximum pain is defined above C_{III} , IG3 points are used – the exposure is 30 seconds (a specific point for the cervical and occipital algia) and V62 – 40 seconds. If the maximum pain is defined below C_{III} , the following points are used: RP4 – the exposure is 30 seconds and MC6 – 30 seconds or TR5 – 30 seconds

and VB41 – 40 seconds. Painful points on the head and neck are also exposed, defined by palpation. If the signs of spastic disorders in carotid and vertebrobasilar vessels are defined, the following points regulating hemocirculation are recommended: F2, F3, C7. If the symptoms of ophthalmic vegetalgia and visual disturbances occur it is possible to expose VB20, VB19, VG16, VG17, VB14, VG23, VG24 points and the points around eyes. In some cases, the exposure along the “visual line” of the scalp gives a good result: on several points for 15 seconds each.

Neurovascular syndromes of the sympathetic tendency predominantly are connected with the neuro-vascular bundle compression by spastic muscles as well as with the activation of vasomotor fibers and the subsequent involvement of suprasegmental formations.

Sacro-iliac neurodystrophic syndrome. Additional points: VG3, VG4, V27–30, V40, V11, VB30, VB34.

Lumbosacral radiculopathy. Additional points in accordance with the concrete symptomatology: VG4, V23, V24, V25, V29, V31–34, VB30, V60, VB34, R2, R6 (3), R7, GI10; if the illumination of pain along the zone (piriformis syndrome) occurs: VB30, V40 (54), V36 (50), V57.

Discirculatory Encephalopathy

Our studies have proven to have maximum efficiency if the exposure is with the matrix pulsed laser heads of the red spectrum on the projection of the main arteries of the head in the treatment of patients with discirculatory encephalopathy (chronic cerebral ischemia) [Leyderman N.E. et al., 2009]. A.V. Kochetkov and co-authors (2005).

NLBI technique (Table 7), contact, stable with the ML-635-40 matrix pulsed laser head in the red spectrum (wavelength is 635nm, maximum power is 40W, frequency is 80–150Hz), the exposure on a zone is for two or five minutes, there are 8–15 procedures per course. The exposure localization depends on the clinical and hemodynamic features of the disease development and course:

- the exposure is implemented on the projection of the common carotid arteries (symmetrically) with the prevalence of carotid insufficiency syndrome (anterior localization);
- the exposure is implemented on the posterior-lateral surface of the neck (posterior localization, symmetrically) with vertebral-basilar insufficiency syndrome.

OR

ILBI technique (Table 5 or 6), there are 8–10 daily procedures. NLBI and ILBI must not be implemented together in one day!

Ischemic and Traumatic Myelopathy

Low level laser therapy with spinal trauma not only contributes to the improvement of microcirculation in the zone of the spinal cord trauma (vagospasm is removed), but is applied for the treatment and prevention of pressure ulcers, and infectious complications of the urinary tract and respiratory system. V.V. Stupak (1999) showed that ILBI contributes to a faster normalization of the immunological parameters of patients with spinal trauma, which contributes to the prevention of the development of the purulent pulmonary complications. ILBI and the local illumination of the contusion foci of the spinal cord by pulsed IR LILI allow a faster recovery of the lost spinal cord function with a pronounced regress of neurological symptoms, prevent the development of pressure ulcers and allow 3-time faster restoring of spontaneous urination comparing with the control.

The technique is contact-mirror, stable with the LO-904-20 pulsed IR laser head and the ZN-35 mirror nozzle (wavelength is 904nm, power is 10–15W, frequency is 80–150Hz), for 1.5–2 minutes on a zone. On the peripheral nerves the exposure is implemented on several zones (no more than 6 during one procedure):

- paravertebral region of the corresponding segment of the spinal cord (symmetrically).
- the most painful zones (2–3).
- nerve ending injury area.
- temporal regions (2cm back from the outer corner of the orbit, symmetrically).

ILBI technique (Table 5 or 6), there are 10–12 daily procedures per course.

Myofascial Pain Syndrome

Low level laser therapy of patients with myofascial pain syndrome (MFPS) can be applied both as a basic or an additional method in the complex treatment of chronic vertebrogenic lumbar ischialgia. The course of treatment includes 12 daily procedures. A.A. Liev and co-authors (1996) defined the main trigger points (TP), which are presented in Fig. 35–43. Combined with arthro-motor reactions (of the sacroiliac joint,

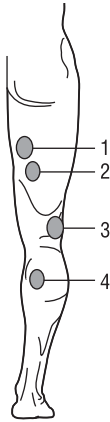

Fig. 35. TP of the biceps of the thigh (1, 2), semimembranosus muscle (3) and popliteal muscle (4)

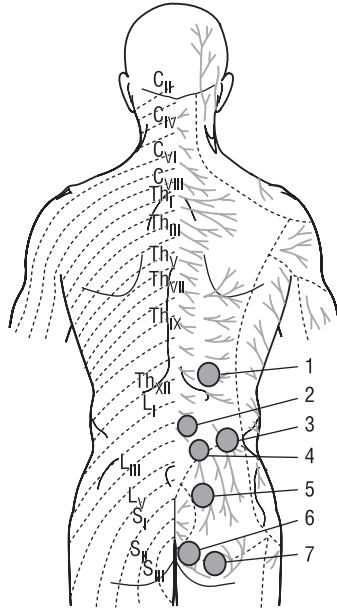

Fig. 36. TP of the lumbar quadrate muscle (1, 3), back extensors (2, 4), parts of the gluteus maximus (5, 6, 7)

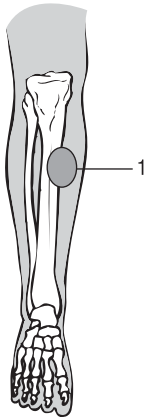

Fig. 37. TP of the tibialis anterior muscle (1)

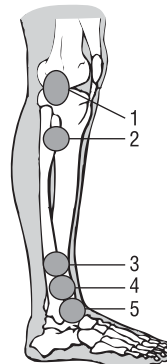

Fig. 38. TP of the knee joint collateral ligament (1); TP of the peroneal muscle: 2 – *m. peroneus longus*, 3 – *m. peroneus brevis*, 4, 5 – *m. peroneus tertius*

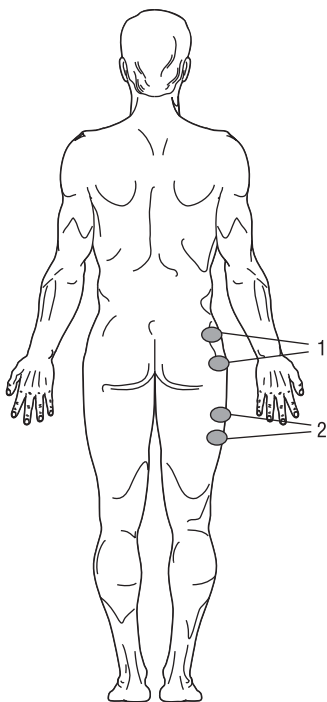

Fig. 39. TP of the muscles straining broad fascia of the thigh (1); combined TP of the muscle straining broad fascia thigh and vastus lateralis muscle (2)

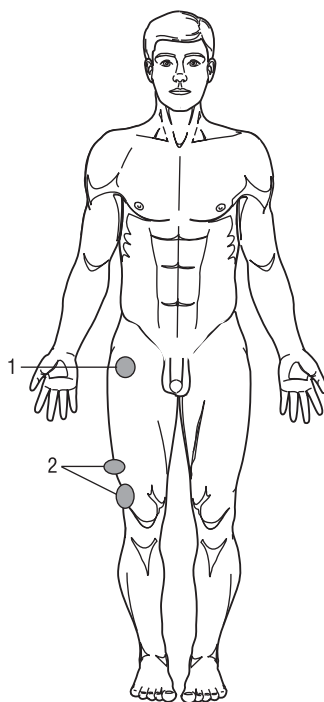

Fig. 40. TP of the rectus femoris (1) and vastus lateralis muscle (2)

hip joint, knee joint) regardless of the TP location, LLLT is obligatorily implemented paravertebrally at L_{III}–S_I level.

Technique 1. Contact-mirror, stable with the LO-904-20 pulsed IR laser head and the ZN-35 mirror nozzle (wavelength is 904nm, power is 10–15W, frequency is 3000Hz), successively for five minutes on each TP [Kubasova E.S., 1999].

Technique 2. Contact-mirror, stable. The exposure time on one trigger point is 1–2 minutes. The procedure time must not exceed eight minutes. Some points are exposed with two laser heads simultaneously. Depending upon the form of pathology, pulsed IR or pulsed red laser heads are used (Table 10). The LO-904-20 pulsed laser head with the ZM-50 magnet

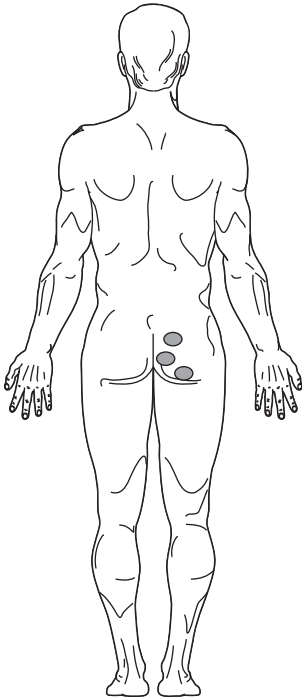

Fig. 41. TP of the gluteus maximus

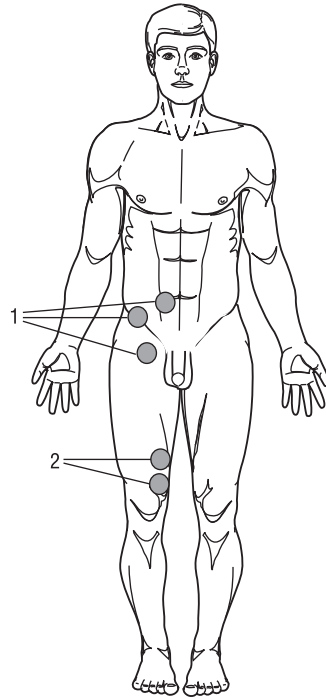

Fig. 42. TP of the iliopsoas muscle (1) and the quadriceps femoris (2)

Table 10

Emitting heads recommended for the LLLT course of patients with MFPS

Pathology form	Head type
Musculo-tonic lumbar ischialgia	LO-904-20
Musculo-dystrophic lumbar ischialgia	LO-904-20
Neurovascular dilatation lumbar ischialgia	LO-904-20 and LO-635-5
Neurovascular constriction lumbar ischialgia	LO-904-20 and LO-635-5
Mixed	LO-904-20 and LO-635-5
Combined with coccygodynia syndrome	LO-904-20

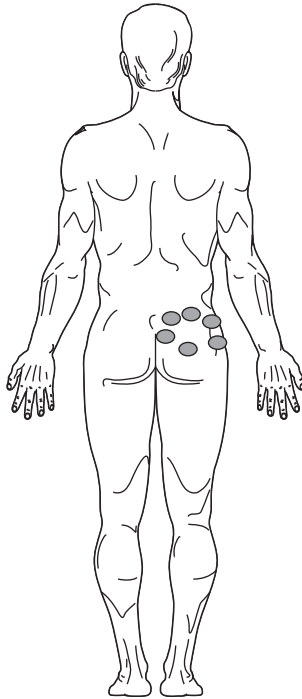

Fig. 43. TP of the piriform, medium and small gluteal muscles

nozzle is more often used (wavelength is 904nm, power is 10–15W), frequencies are given in Table 11. It is more preferable to expose the areas with latent trigger points with LO-635-5 pulsed laser head without a nozzle or with A-3 acupuncture nozzle (wavelength is 635nm, maximum power is 5W, frequency is in accordance with Table 11).

Table 11

**Dynamics of the pulse repetition frequency alteration
for the LO-904-20 laser heads (IR pulsed) in the LLLT course
of patients with MFPS**

Procedure	1	2	3	4	5	6	7	8	9	10	11	12
Frequency, Hz	80	150	300	600	1500	3000	1500	1500	600	300	150	80

Trigeminal Neuralgia

LLLT technique is contact-mirror, stable with the LO-904-20 pulsed IR laser head with the ZN-35 mirror nozzle (wavelength is 904nm, power is 10–15W, frequency is 80–150Hz), for 1.5–2 minutes on a zone. Every day on the points where the affected branches of the trigeminal nerve emerge, 3–4 pain zones along 1, 2, 3 lines and on the area of the upper cervical sympathetic ganglion – zone 4 (under the mandible angle) symmetrically (Fig. 44). There are 8–10 procedures per course.

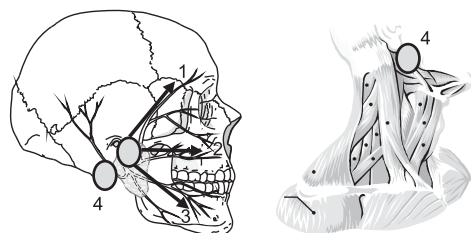

Fig. 44. Exposed zones for trigeminal neuralgia: 1st branch (ocular nerve) – the superciliary arch in the superior orbital fissure of the skull; 2d branch (maxillary nerve) – the center of the pterygomaxillary fossa; 3d branch (mandibular nerve) – the area of mental foramen of the mandible; 4 – the projection of the superior cervical sympathetic ganglion

Laser acupuncture. It is possible to use other points additionally to the basic method (Fig. 11).

With *neuralgia of the first branch of the trigeminal nerve* (occurs in 3–5% cases of the trigeminal nerve lesion): VB14, E8, TR23, VB1, V2, V1.

With *neuralgia of the second branch of the trigeminal nerve*: E2, E7, GI19, GI20, E3, E4, TR17, IG18.

With *neuralgia of the third branch of the trigeminal nerve*: TR17, E6, E5, VC24.

Neurasthenia

LLLT technique is contact-mirror, stable with the LO-904-20 pulsed IR laser head and the ZM-50 magnet nozzle (wavelength is 904nm, power is 10–15W, frequency is 80–150Hz), for 1.5–2 minutes on a zone, successively: paravertebrally on the collar zone (2), on the projection of the

subclavian vein (3), on the projection of the thymus (4), of the liver (5), of the pancreas (7), of the cecum (8) and of the sigmoid colon (8) (Fig. 45).

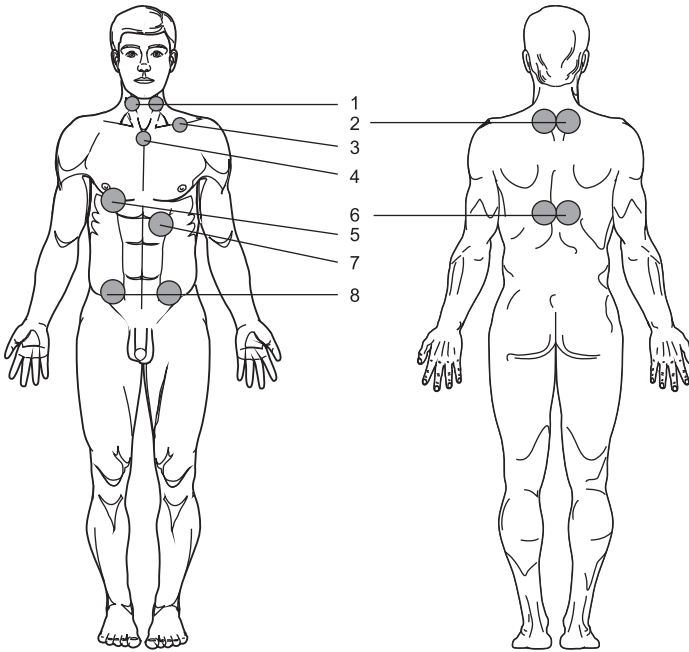

Fig. 45. Exposed zones for neurosis

Laser acupuncture (Table 4). With *hyper- and hyposthenic forms* of the disease, irritable weakness additionally to the basic method (Fig. 11) 2–3 AP: C7, GI11, V60, VG20, VC22, RP6, R4, R6, P9, P4. With *anxiety* the following points are used: C7, V11; with *cardiophobia*: C7, IG3, VG14; with *obsessive-compulsive disorder*: MC6, C7, R5, V15, VC14, VC17; with *insomnia*: GI11, P5, P7, P9, C5, C7, V62, V13, R6, TR5, VG14, VG20, VC3, VC4, VC6, VC13, VC14; with *persistent insomnia* the most effective are the following points: C7, V43 (38), V60, PC3.

Neuroinfections (Meningitis and Meningoencephalitis)

Low level laser therapy as a nonspecific and effective corrector of the immune system is particularly relevant in this case. Numerous studies prove the reasonability of ILBI, and state that sometimes, there is no

alternative in treatment of patients with these diseases [Mikhaylova E.V., 2000; Skupchenko V.V. et al., 1989].

ILBI technique (Table 5 or 6), there are 7–15 daily procedures per course. The exposure parameters are varied according to a patient's age and condition.

Facial Nerve Neuropathy (Neuritis)

The recovery of motor functions after low level laser therapy can already be observed in most patients during the 2nd week of the illness, in 1/3 of patients by the 5–6th sessions [Skupchenko V.V., Makhovskaya T.G., 1993].

Low level laser therapy is implemented in the acute, recovery and residual periods, with postneuritic contracture of the facial muscles of I–II degree.

On the intact side of the face. The technique is contact-mirror, stable with the LO-904-20 pulsed IR laser head and with the ZN-35 mirror nozzle (wavelength is 904nm, power is 10–15W, frequency is 80–150Hz), for 1.5–2 minutes on a zone. The exposure is implemented on the fields in the region where the facial nerve trunk emerges from the skull and along the projection of its branches (Fig. 46). With the orbital muscle lesion (incomplete closure of the eyelids, lacrimation) fields 2 (1cm outwards from the lateral border of the orbit) and 3 (along the inner border of the upper third of the masseter in the region of the pterygopalatine fossa) are exposed. With the flatness of the nasolabial fold, drooping corner of the mouth, its incomplete closure, the exposure is implemented on fields 3, 4 (along the outer border of the middle third of the masseter) and 5 (1cm up and inward from the mandible angle). In all the cases zone 1 must be

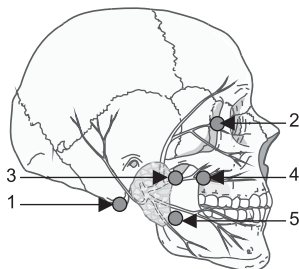

Fig. 46. Exposed zones for neuritis of the facial nerve

exposed for one minute (the tip of the mastoid). The treatment scheme:
See *Trigeminal neuralgia*

On the damaged part of the face. The technique is contact-mirror, stable with the KLO-635-15 laser head and with the ZN-35 mirror nozzle (wavelength is 635nm, continuous mode, maximum power is 10–15mW) for 0.5 minutes on each painful point along the nerve line.

With neuritis as well as with neuralgia the additional exposure on the region of the superior cervical and stellate sympathetic ganglions is possible. The technique is contact-mirror, stable with the LO-904-20 pulsed IR laser head and the ZN-35 mirror nozzle (wavelength is 904nm, power is 10–15W, frequency is 80–150Hz), for 10–20 seconds on a zone; for 20–30 seconds on the tip of the mastoid. Taking into consideration the fact that the blood is supplied from the internal auditory artery (a branch of the main) to the facial nerve, the petrous artery (a branch of the middle meningeal artery, which, in turn, is a branch of the maxillary artery), the stylomastoid artery (from the external carotid artery), it is necessary to also implement LILI on these arteries (NLBI technique, Table 7). To improve the metabolism, the areas of the liver and pancreas are exposed, for two minutes on each zone.

ILBI technique (Table 5 or 6), there are 8–10 daily procedures per course.

Sciatic Nerve Neuropathy

LLLT technique is contact-mirror, stable with the LO-904-20 pulsed IR laser head and the ZN-35 mirror nozzle (wavelength is 904nm, power is 10–15W, frequency is 80–150Hz), for 1.5–2 minutes on a zone, on the points where the nerve emerges and on pain zones along the nerve successively from zone 1 to 6 (Fig. 47).

Acute Cerebrovascular Disease

Our data indicates the undeniable prospect of the use of the ML-635-40 pulsed matrix laser heads of the red spectrum (wavelength is 635nm, maximum power is 40W, frequency is 80–150Hz) with different cerebrovascular pathology, first of all, in the treatment of patients with cerebral stroke [Kochetkov A.V., Moskvina S.V., 2004].

NLBI technique (Table 7, wavelength is 635nm).

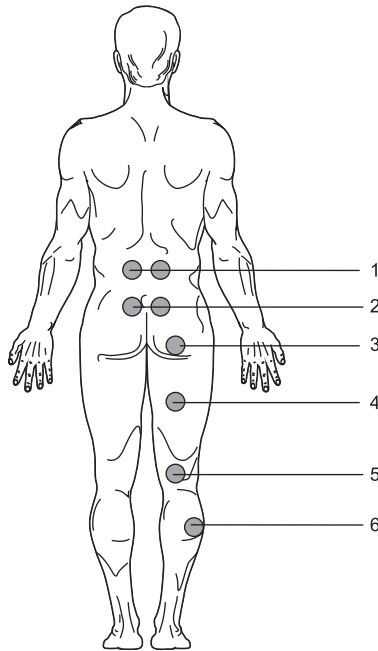

Fig. 47. Exposed zones for sciatic nerve inflammation

Polyneuropathy

Laser acupuncture (Table 4, wavelength is 635nm, modulated mode, frequency is 2Hz). In the first half of the day the distal points of the arm and leg the Yang-meridians: GI1, TR1, IG1, E45, VB44, V67 are exposed symmetrically from both sides. At the second stage, the exposure is on the sympathetic points (shu-points) of the small intestine meridian V27 from both sides. In the second half of the day the exposure is on the distal points of the Yin-meridians, symmetrically: P11, MC9, C9, RP1, F1, R1. Then the sympathetic points (shu-points) of the liver meridian V18 are exposed from both sides. Up to 14 points per procedure, up to 28 points per day. The exposure on one point: GI1; TR1; IG1; E45; VB44; V67; P11; MC9; C9; RP1; F1; R1 is 30 seconds, on V27 is 10 seconds, on V18 is 50 seconds; every day, two times a day with an interval of 4–6 hours, there are 10–12 procedures per course. Good results are shown, in par-

ticular, with autonomic-sensory post-radiation polyneuropathy [Zakharov Ya.Yu., 2002].

ILBI technique (Table 5 or 6), there are 15–20 daily procedures per course.

Combined. The technique is contact-mirror, stable with the LO-904-20 pulsed IR laser head and the ZM-50 magnet nozzle (wavelength is 904nm, power is 10–15W, frequency is 80–150Hz), for 1.5–2 minutes on 4–5 zones:

- on the projections of the neurovascular bundles of the lower limbs (direct effect on the functional condition of the nerve fibers),
- on the projection of the large vessels (systemic effect on blood flow),
- paravertebrally on the zones of segmental innervations (ganglia of the lumbosacral region).

With diabetic distal polyneuropathy LLLT contributes to the improvement of the functional condition of the peripheral nerve fibers. The duration of the course of treatment must not exceed 10 days. The second course of the combined LLLT is not possible earlier than in 6–8 months. [Busalayeva E.I, 1999].

Traumatic Brain Injury

The restriction for ILBI is a massive subarachnoid hemorrhage. It should be emphasized, that ILBI is allowed in the complex intensive therapy of the acute period of severe traumatic brain injury beginning with the 2nd–3rd day of the postoperative period taking into consideration the careful intraoperative hemostasis.

ILBI technique (Table 5 or 6), there are 7–12 daily procedures per course. LLLT favorably influences the antioxidant system, improves blood rheology, and has immunomodulatory and membrane stabilizing effects [Klimova L.V., 1998].

Low level laser therapy can be implemented for the prevention of the traumatic brain injury complications (cerebral ischemia, pneumonia, pressure ulcers, etc.), for the reduction of intracranial hypertension or of the difficulty of venous outflow from the cranial cavity, and with the overproduction of cerebrospinal fluid. The technique is contact-mirror, stable with the LO-904-20 pulsed IR laser head and the ZN-35 mirror nozzle (wavelength is 904nm, power is 10–15W, frequency is 80–150Hz), for 0.5–1 minute on the superior cervical sympathetic ganglion.

Postoperative Complications

LLLT contributes to the smooth post-traumatic and postoperative periods, in clinical terms the efficiency of treatment of neurosurgical patients (traumatic brain injury, tumors, vascular diseases) is, first of all, in the regress of the cerebral symptoms: the reduction of the degree of the impaired consciousness, of the severity of psychomotor disorders and of the headache intensity.

ILBI technique (Table 5 or 6), there are 8–10 daily procedures per course.

Radicular Syndrome after Discectomy

Radicular syndrome after discectomy of patients with lumbar osteochondrosis in 12–14% of cases becomes highly persistent. LLLT evokes vegetative-vascular, muscular-tonic responses and the antioxidant system activation [Grishanova Yu.D., 1995].

ILBI technique (Table 5 or 6), there are 8–10 daily procedures per course.

Multiple Sclerosis

Low level laser therapy is recommended for patients who have had the disease no longer than 7 years. The best results of treatment are obtained with patients having a vegetative background of the adrenergic orientation, and tension of the immune system at B-receptors level predominantly, the increase of the immunoglobulin class and circulating immune complexes [Skupchenko V.V., Makhovskaya T.G., 1993].

ILBI technique (Table 5 or 6), there are 7–15 daily procedures per course. The parameters of the exposure are varied in accordance with a patient's age and condition.

Chronic Fatigue Syndrome

Laser acupuncture (Table 4). The exposure is implemented on the basic method points (Fig. 11) with modulation, frequency is 2.4Hz. Additionally, every other day, the exposure on point VG20 is implemented for 30 seconds and “thalamus” AP for 10 seconds. If a patient feels an expressed general tone reduction before the procedure, the “Shi-xuan” points (the finger tips) are exposed first, and then the main procedure is implemented.

ILBI technique (Table 5 or 6), there are 7–15 daily procedures per course. The parameters of the exposure are varied in accordance with a patient's age and condition.

Cerebral Stroke

ILBI with cerebral ischemia has a positive effect on the central and regional hemodynamics (arteriodilating and venotonic effects), has a sedative and antispasmodic effect. In 86% of cases a positive result of treatment is achieved, it is proved that mortality is 1.5–2 times less compared to the control. On the 2–3rd session of ILBI, a considerable regress (by tens of percentages) of the main clinical symptoms and syndromes (headache, dizziness, noises in the head, tachycardia, tremor, arterial hypertension) occurs. ILBI is most efficient for patients with the period of the identified disease of up to 1 year. [Kochetkov A.V., Moskvina S.V., 2004; Skupchenko V.V., Makhovskaya T.G., 1993; Khazov S.V. et al., 1998].

ILBI technique (Table 5 or 6), there are 8–10 daily procedures per course.

Epilepsy

Low level laser therapy provides the increase of energy and the bio-potential of neurocytes and corrects their rhythmic activity. LILI has a sedative, mildly soporific, antispasmodic and anticonvulsant effect, as it directly influences the brain and autonomic centers. That is proved by our representational dynamic studies of dopplerography and EEG indicators with multifocal epileptic complex with suppression of excitation foci by laser exposure in the end. It is shown, that with the therapeutic effect of LILI on blood, epileptogenic zones and acupuncture points, the corrective changes of the activity of the neuronal formations and other structures of the brain occur [Patent 2149655 RU].

LLLT technique is combined, all methods are implemented. The initial treatment is alongside the use of medication. LILI exposure ensures the correction of the function of various brain structures as well as the metabolism, as a result, the complex therapy efficiency is increased and a further reduction of drug doses is achieved, and if there is no paroxysm according to the EEG data, drugs are completely removed.

ILBI technique (Table 5 or 6).

Contact-mirror technique, stable with the LO-904-20 pulsed IR laser head and the ZN-35 mirror nozzle (wavelength is 904nm, power is 10–15W, frequency is 80–150Hz), for two minutes on each epileptogenic zone symmetrically: temporal, parietal, from the base of the skull to the top.

Contact-mirror technique, stable with the LO-904-20 pulsed IR laser head and the ZN-35 mirror nozzle (wavelength is 904nm, power is 10–15W, frequency is 80–150Hz), paravertebrally for 0.5 minutes on the C_I–C_{VI} areas.

Laser acupuncture (Table 4) on the points: T24, T23, T21, T20, T19, T18, T16, VB20. Additionally, E13 – 20 seconds every day, on GI4 and E36 points every other day – 2 points (1st day) and on MC6 and RP6 points – 2 points (2nd day).

The course of treatment consists of 10–16 procedures, the first 5 procedures are implemented every day, the rest – every other day, the course is repeated in 3–3.5 months no less than 3–4 times.

Otorhinolaryngology

Adenoid Vegetations of II–III Degree

The exposure is with the LO-635-5 pulsed laser head of the red spectrum (wavelength is 635nm, maximum power without a nozzle is 5W, frequency is 80–150Hz), endonasally (for one minute on each half of the nose), through the open mouth (the laser head without a nozzle is set up at the level of the front teeth) for two minutes, then with the LO-904-20 pulsed IR laser head and the ZN-35 mirror nozzle (wavelength is 904nm, power is 10–15W, frequency is 80–150Hz), transdermal for 1.5–2 minutes successively on areas 2, 4, 5, 7, 8 (Fig. 48). There are 5–7 daily procedures per course.

The course of low level laser therapy is repeated in 2–3 months. The 3rd course is implemented in 6 months. Adenoid vegetations are decreased to I degree sizes, nasal breathing of practically all the patients is restored. In most cases no recurrences of the disease are observed.

Eustachitis, Otitis External and Media. Cochleoneuritis. Meniere's Disease

Low level laser therapy is implemented against the background of medication. After the auditory meatus, toilet the exposure of the area

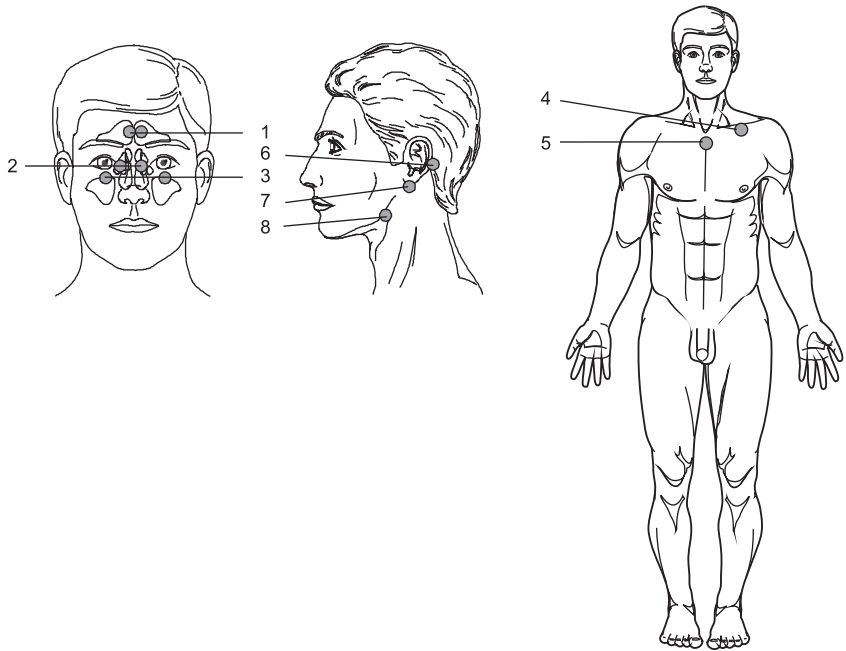

Fig. 48. Exposed zones for ear, nose and throat disorders

of the entrance of the auditory meatus with the KLO-635-15 laser head (wavelength is 635nm, continuous mode, maximum power is 10–15mW) is implemented symmetrically with the help of L-1 otorhinolaryngology nozzles. Then the transdermal exposure is implemented, the technique is contact-mirror, stable with the LO-904-20 pulsed IR laser head (wavelength is 904nm, power is 10–15W, frequency is 80–150Hz) for one minute successively, on areas 6, 7, 8, 4, 5 (Fig. 48). There are 5–7 daily procedures per course; the course is repeated in 3 weeks.

A positive effect of ILBI with Meniere's disease (subjective noise reduction, increase of the value of the differential threshold of the perception of sound power) is achieved in 79.2% of patients [Reshetnikova N.L., Stegunina L.I., 1998].

ILBI technique (Table 5 or 6), there are 5–7 daily procedures per course.

Sensorineural Hearing Loss

ILBI technique (Table 5 or 6), there are 5–7 daily procedures per course.

Acute Rhinitis

LLLT technique is contact, stable with the LO-904-20 pulsed IR laser head and the ZM-50 magnet nozzle (wavelength is 904nm, power is 10–15W, frequency is 80–150Hz) for 1.5–2 minutes successively, on areas 2, 3, 8, 4, 5 (Fig. 48).

It is possible to implement the endonasal exposure additionally for one minute on each half of the nose with the help of L-1 otorhinolaryngology nozzles with the KLO-635-15 laser head (wavelength is 635nm, continuous mode, maximum power without a nozzle is 10–15mW). There are 5–7 daily procedures per course.

Rehabilitation after Rhinosurgery

Postoperative complications can occur quite often, such as prolonged swelling of the nasal mucosa and dystrophic rhinitis symptom complex with crust formation, dry nose.

Low level laser therapy is implemented transdermally, symmetrically for two minutes on each half of the nose with the LO-635-5 pulsed laser head (wavelength is 635nm, maximum power is 5W, frequency is 80–150Hz) or endonasally with the KLO-635-15 laser head (wavelength is 635nm, continuous mode, maximum power without a nozzle is 10–15mW) with the help of the L-1 otorhinolaryngology nozzles. There are 5–7 daily procedures per course.

Tonsillectomy

The treatment is implemented alongside medication. For the stimulation of the regeneration of pharyngeal wounds of patients after a bilateral tonsillectomy, low level laser therapy is recommended from the second day after the operation. The technique is contact-mirror, stable with the LO-904-20 pulsed IR laser head and the ZN-35 mirror nozzle (wavelength is 904nm, power is 10–15W, frequency is 80–150Hz) for 1.5–2 minutes successively on areas 2, 4, 5, 7, 8 (Fig. 48). There are 3–5 daily procedures per course.

Chronic Vasomotor Rhinitis

LLLT technique is similar to the acute rhinitis treatment technique. The therapy can require several courses alongside a diet. Preventive courses should be implemented regularly in spring and autumn.

Chronic Maxillary Sinusitis, Frontal Sinusitis

Low level laser therapy is implemented if there is an outflow from the nasal cavity (natural or postoperative). If there is purulence in the affected sinus, everyday washing and purulence evacuation are obligatory before the laser procedure.

The technique is contact-mirror, stable with the LO-635-5 pulsed laser head and the ZN-35 mirror nozzle (wavelength is 635nm, maximum power without a nozzle is 5W, frequency is 80–150Hz), through the front wall of the paranasal sinuses, on zones 1 and 2 for one minute, with the LO-904-20 pulsed IR laser head and the ZN-35 mirror nozzle (wavelength is 904nm, power is 10–15W, frequency is 80–150Hz) on areas 3, 4 and 5 for 1.5–2 minutes (Fig. 48). There are 7–10 daily procedures per course.

Chronic Tonsillitis

Low level laser therapy with different forms of the disease is implemented alongside traditional therapeutic measures (washing, mucous lubrication with medications).

The technique is contact-mirror, stable with the LO-904-20 pulsed IR laser head and the ZN-35 mirror nozzle (wavelength is 904nm, power is 10–15W, frequency is 80–150Hz) for 1.5–2 minutes successively on areas 2, 4, 5, 7, 8 (Fig. 48). It is possible to expose the tonsils and the back wall of the pharynx directly through the mouth with the LO-635-5 pulsed laser head and the ZN-35 mirror nozzle (wavelength is 635nm, maximum power without a nozzle is 5W, frequency is 80–150Hz), with the help of otorhinolaryngology nozzles (the distance to a tonsil is 0.5cm, the tongue is pressed with a metal spatula angled at 90–100 degrees). There are 5–7 daily procedures per course. The repeated courses are implemented in 3–4 weeks.

Chronic Pharyngitis. Nasopharyngitis

The technique is contact-mirror, stable. During the first 5 days the exposure is for one minute with the LO-635-5 pulsed laser head and the ZN-35 mirror nozzle (wavelength is 635nm, maximum power is 5W,

frequency is 80–150Hz), directly on to the back wall of the pharynx (the laser head without any nozzles is set up at the level of the front teeth with an open mouth). Then the exposure with the LO-904-20 pulsed IR laser head and the ZN-35 mirror nozzle (wavelength is 904nm, power is 10–15W, frequency is 80–150Hz) for 1.5–2 minutes successively on areas 2, 4, 5, 7, 8 (Fig. 48).

There are 7–10 daily procedures per course. 2–3 courses of low level laser therapy are implemented with the interval of 3 weeks. Further preventive courses are recommended 2–3 times a year.

Ophthalmology

Diabetic Retinopathy

Evgrafov V.Yu. (2006) proved that the application of ILBI for patients with proliferative diabetic retinopathy makes it possible to improve all the indicators considerably; what is more, the effect lasts for 1–4 months after the end of the treatment course.

ILBI technique (Table 5 or 6), there are 7–10 daily procedures per course.

Vitreous Hemorrhage (Hemophthalmos)

The inclusion of ILBI in the scheme of treatment contributes to blood resorption strengthening, followed by the visual functional improvement. LLLT blocks the toxic effect of the products of hemolysis on the retina, decreases the fibro-proliferative effects in the long term, that reduces the risk of complications with hemophthalmos of various etiology [Deyneka E.D., 1996].

ILBI technique (Table 5 or 6), there are 7–10 daily procedures per course.

Retinal Vein Thrombosis

LLLT leads to the reduction of the coagulation activity of the lacrimal fluid, and leads to the increase of the fibrinolytic activity, the phagocytosis activity is increased, the level of immunoglobulins, circulating immune complexes, molecules of the average mass, and POL (lipid peroxidation) products is decreased. That allows an 11% reduction of the complication development, from a 20% to a 5% reduction of the development of recur-

rent thrombosis and obtaining higher functional outcomes in comparison with traditional therapy [Makhmutova T.I., 1995].

ILBI technique (Table 5 or 6), there are 5–7 daily procedures per course.

Psychiatry

Abstinence Syndrome of Patients with Alcoholism

Strengthening of antioxidant protection and of the oxygen-transport blood function, normalization of the metabolism, detoxifying and sedative effects occur alongside ILBI. A considerable decrease or complete elimination of the use of pharmacological agents is observed, general condition is normalized and basic homeostatic indicators are stabilized faster [Sosin I.K., Chuev Yu.F., 1997].

ILBI technique (Table 5 or 6), there are 2–3 daily procedures per course.

Abstinence Syndrome of Patients with Drug Addictions

Strengthening the antioxidant protection and the oxygen-transport blood function, normalization of metabolism, detoxifying and sedative effects occur alongside ILBI, the general condition is normalized and basic homeostatic indicators are stabilized faster [Sosin I.K., Chuev Yu.F., 1997].

The 1st variant of LLLT technique. During the first 5 days **NLBI** is implemented (Table 7, on the projection of the common carotid artery for 1.5–2 minutes on a zone, asymmetrically). The exposure on the zones of the projections of the liver, pancreas, large intestine and superior cervical sympathetic ganglion is implemented additionally, for two minutes on each zone. The technique is contact, stable with the ML-904-80 matrix pulsed IR laser head and the MM-50 magnet nozzle (wavelength is 904nm, maximum power is 60–80W, frequency is 80–150Hz) [Nasedkin A.A., Moskvina S.V., 2004].

The 2nd variant of LLLT technique. ILBI-635 (Table 6, power is 6–8mW, exposure is 30–40 minutes), during the first 2–3 days with the interval of 6–8 hours twice a day. Additionally, with severe abstinent disorders **NLBI** is implemented (Table 7, on the projection of the common

carotid artery for 1.5–2 minutes on a zone). Beginning with the 4–5th day, laser acupuncture, detoxification, restorative vegetotropic and sedative treatment are included into the complex.

The 1st and 2nd variants can be combined, but must not be used simultaneously!

Schizophrenia

ILBI influences the central and regional hemodynamics, and has sedative, anxiolytic and antispasmodic effects, the amount of drugs taken and the treatment period are reduced [Kartelishev A.V., Vernekina N.S., 2000].

ILBI technique (Table 5 or 6), there are 8–10 procedures per course, every day or every other day. Additionally, exposure on the zones is implemented, the technique is contact-mirror, stable with the LO-904-20 pulsed IR laser head and the ZN-35 mirror nozzle (wavelength is 904nm, power is 10–15W, frequency is 80 and 1500Hz alternately), the exposure is 15–30 seconds alternately on each zone on the following regions: large neuro-vascular bundles on both sides of the neck, the anterior temporal, orbital and occipital areas, the 7th cervical vertebra (C7). The treatment is implemented alongside psycho-pharmacotherapy.

Endogenous Psychoses

In the complex treatment of drug-resistant affective disorders of patients with endogenous psychoses, ILBI is recommended for the treatment of mostly melancholy-depressive and anxiodepressive syndromes. An ILBI course is advisable if there are no positive dynamics of mental disorders within 3 weeks from the moment of prescription of traditional pharmacotherapy (if there are clinical signs of relative resistance and the formation of a negative drug pathomorphism). To control the efficiency of the therapy, an experimental psychological (differentiated self-concept test) examination and psychophysiological (study of the attention switching, visual-active thinking study, study of the subjective perception of time slots) examination, an assessment of the condition and dynamics of the nonspecific resistance of the organism (analysis of the types of adaptive reactions), as well as of the lipid peroxidation indicators are recommended together with the clinical examination. Positive clinical dynamics are registered in 57% of patients, as well as in 64% of cases the normalization of psychological and psychophysiological indicators was

observed. The efficiency of ILBI is not the same with different options of depressive syndrome. The improvement of the mental condition was observed in 70.6% of patients with melancholy-depressive syndrome, in 53.8% with anxiodepressive syndrome, and in 39% with apathy-depressive syndrome. The improvement of the mental condition of patients during low level laser therapy is accompanied by the normalization of the nonspecific resistance system indicators. In the case of positive clinical dynamics, the reduction of the frequency of adaptive reactions of a pathological type went from 52.6% to 10.6%, and a decrease of the level of malondialdehyde in plasma is observed [Perstnev S.V., 1995].

ILBI technique (Table 5 or 6), there are 5–7 daily procedures per course.

Pulmonology

Lung Abscess

Low level laser therapy is implemented alongside antibacterial, detoxifying and anti-inflammatory therapy. If necessary, drainage of intrapulmonary abscesses and lung empyema is provided [Temirbulatov V.I., 1994].

ILBI technique (Table 5 or 6), there are 5–7 daily procedures per course.

Bacterial Destruction of the Lungs

According to A.O. Ledin's data (1994), the inclusion of ILBI in the complex treatment during the postoperative period allows a 12.5 time decrease of complications, 1.4 times reduction of treatment duration in a total absence of fatal cases.

Particular contraindications: polygonal abscess form with hard-to-reach areas, more than 150 ml of purulent exudation per day.

ILBI technique (Table 5 or 6), there are 5–7 daily procedures per course.

Bronchial Asthma. Allergic Processes in the Lungs

Low level laser therapy is implemented alongside medication with a gradual dose reduction or cancelation in accordance with the improvement of the patient's condition, as well as physiotherapy and adequate types of breathing exercises.

ILBI technique (Table 5 or 6), there are 5–7 daily procedures per course.

The exposure on fields 2, 3, 4 is implemented additionally to ILBI successively for 1.5–2 minutes (Fig. 49). The technique is contact, stable with the ML-904-80 matrix pulsed IR laser head and the MM-50 magnet nozzle (wavelength is 904nm, maximum power is 60–80W, frequency is 80–150Hz)

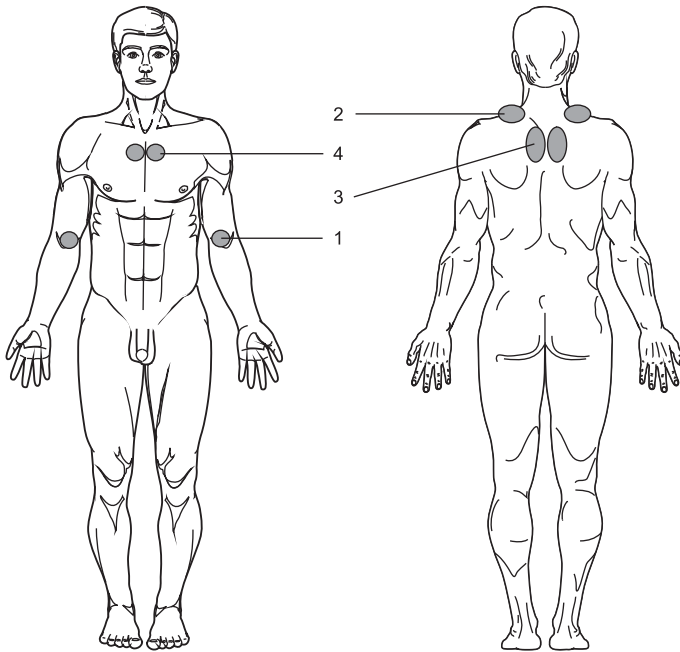

Fig. 49. Exposed zones for chronic obstructive bronchitis, bronchiectasis and pneumonia

Bronchiectatic Disease

According to I.A. Zarembo (1989), N.M. Shelygina and co-authors (1989), the improving of the condition of patients with bronchiectatic disease is registered after the first 2–3 ILBI procedures: a reduction of coughing, breath decrease, amount of sputum, chest pain intensity and sleep improvements are observed. Positive dynamics of the disease

course is strongly pronounced, which leads to a 3–4 day reduction of the hospital stay.

ILBI technique (Table 5 or 6), there are 5–7 daily procedures per course.

Acute Bronchitis and Chronic Bronchitis in the Exacerbation Phase

The treatment is implemented alongside antibacterial therapy and other medications (antibiotics, bronchodilators, mucolytics, vitamins, etc.).

Low level laser therapy is prescribed after the normalization of the body temperature and severe intoxication elimination (on average 5 days from the beginning of etiotropic treatment). The technique is contact, stable with the ML-904-80 matrix pulsed IR laser head and the MM-50 magnet nozzle (wavelength is 904nm, maximum power is 60–80W,

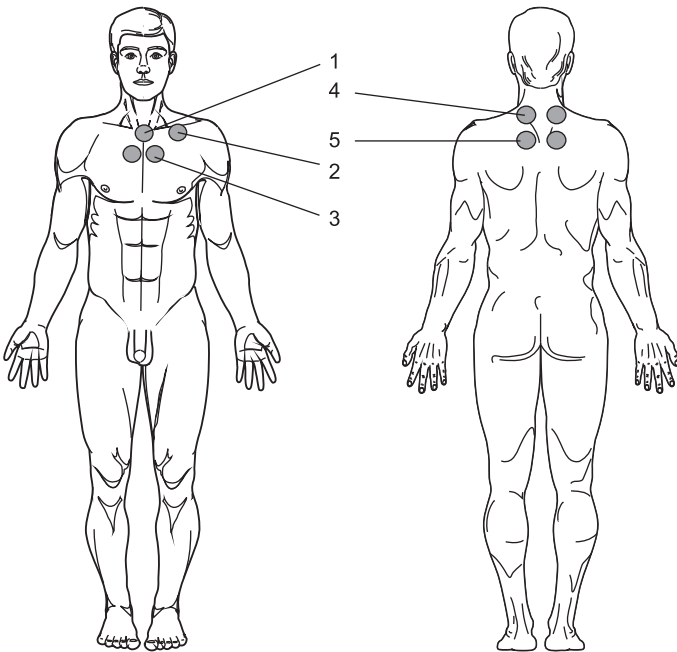

Fig. 50. Exposed zones for bronchitis

frequency is 80–150Hz), on fields 1–5 successively for 1.5–2 minutes (Fig. 50). There are 12 daily procedures per course. During the whole course of treatment, a patient must not eat or drink anything cold. The course can be repeated in 3 weeks.

Acute Pneumonia. Exacerbation of Chronic Pneumonia

Low level laser therapy alongside medication is prescribed 1–2 days after getting positive results from etiotropic treatment (body temperature stabilization, wheezing decrease, decrease of toxins).

The technique is contact, stable with the ML-904-80 matrix pulsed IR laser head and the MM-50 magnet nozzle (wavelength is 904nm, maximum power is 60–80W, frequency is 80–150Hz), successively for 1.5–2 minutes on the zones of the projection of the inflammatory infiltrate of the lung tissue on the chest, and (Fig. 49) on zones 2 (Kronig's isthmus), 3, 4. There are 12 daily procedures per course.

Preventive courses of low level laser therapy with chronic pneumonia are implemented 1–2 times a year, in the spring and autumn periods.

Pleuritis

Low level laser therapy is prescribed in the resorption phase. The combination with physiotherapy and breathing exercises are necessary.

The technique is contact, stable with the ML-904-80 matrix pulsed IR laser head and the MM-50 magnet nozzle (wavelength is 904nm, maximum power is 60–80W, frequency is 80–150Hz), for five minutes on the affected area. If the focus is large, the technique is labile: slow scanning is implemented along the intercostals spaces on the back from the side of the pleural effusion, capturing the lateral surface (along midaxillary line).

Chronic Nonspecific Lung Diseases

ILBI in the complex therapy of patients with an infectious-dependent form of bronchial asthma and chronic obstructive bronchitis contributes to the faster relief of the main symptoms of the disease and to the clinical remission, which is achieved in a shorter time in comparison with the traditional method without low level laser therapy [Zaremba I.A., 1989].

ILBI technique (Table 5 or 6), there are 7–10 daily procedures per course.

Chronic Obstructive Bronchitis

ILBI in the complex therapy of patients with chronic bronchitis leads to faster remission, which is accompanied by the improvement of the indicators of respiratory functions and by the decrease in the intensity of lipid peroxidation [Babina E.M., 1995; Smirnova M.S., 1996].

The technique is contact, stable with the ML-904-80 matrix pulsed IR laser head and the MM-50 magnet nozzle (wavelength is 904nm, maximum power is 60–80W, frequency is 80–150Hz), successively for 1.5–2 minutes on fields 2, 3, 4 (Fig. 49).

ILBI technique (Table 5 or 6), there are 5–7 daily procedures per course.

Dentistry

The application of LLLT in dentistry is limited by the additional particular contraindications:

- all forms of leukoplakia;
- proliferative processes on the oral mucosa (papillomatosis, limited hyperkeratosis, rhomboid glossitis).

Temporomandibular Arthritis

LLLT technique is contact-mirror, stable with the LO-904-20 pulsed IR laser head and the ZN-35 mirror nozzle (wavelength is 904nm, power is 10–15W, frequencies of 80–150Hz – regeneration and intensification of microcirculation, 3000–10,000Hz – analgesic effect, during the first 2–3 procedures). The exposure is implemented by fields, taking into consideration the anatomical joint borders, on the points of maximum pain up to five minutes.

Additionally, zones 1, 2, 5 and 4 (Fig. 51) are exposed successively for 1.5–2 minutes. The technique is contact, stable with ML-904-80 matrix pulsed IR laser emitting head with MM-50 magnet nozzle (wavelength is 904nm, power maximum is 60–80W, frequency is 80–150Hz).

Aphthous and Herpetic Stomatitis

Low level laser therapy is implemented alongside traditional medication with the help of stomatology nozzles from the S-1 set with the KLO-635-15 laser head (wavelength is 635nm, continuous mode, maxi-

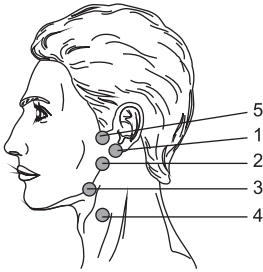

Fig. 51. Exposed zones for the dysfunction of the temporomandibular joint, Melkersson-Rosenthal syndrome, sialadenitis, etc.

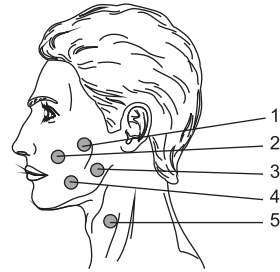

Fig. 52. Exposed zones for gingivitis, periodontitis, and aphthous stomatitis

num power is 10–15mW), for 1.5–2 minutes on each affected zone. The technique is distant, intraoral, the air gap between the stomatology nozzle and the mucosa is about 0.5–2cm. Then, successively for 1.5–2 minutes on zones 1–5 (Fig. 52). The technique is contact-mirror, stable with the LO-904-20 pulsed IR laser head and the ZN-35 mirror nozzle (wavelength is 904nm, power is 10–15W, frequency is 80–150Hz).

Periodontal Disease (Gingivitis, Parodontitis)

The first step of the local treatment is always the removal of dental plaque, tooth surface polishing and proper oral cavity hygiene teaching.

Technique 1. Combined. The exposure (on the fields) of the area of papillae and marginal gingiva with a 1–2cm capture of the alveolar ridge mucosa is implemented with the help of the stomatology nozzles from the S-1 set with the KLO-635-15 laser head (wavelength is 635nm, continuous mode, power maximum without a nozzle is 10–15mW). Then, the external exposure along the maxilla and mandible successively for 1.5–2 minutes on zones 1–5 (Fig. 52). The technique is contact-mirror, stable with the LO-904-20 pulsed IR laser head and the ZN-35 mirror nozzle (wavelength is 904nm, power is 10–15W, frequency is 80–150Hz). The procedure time is 10–12 minutes. The second course is in 4–8 weeks.

Technique 2. Laser acupuncture (Table 4). Modulated mode, modulation frequency is 70Hz, the exposure time on one point is 10–20 seconds, successively on the points: P7, GI4, E4, E5, E6, E7, E36, MC6,

TR5, TR17, VG26, VG28, VC20, VC24, AP51, AP61. The course of treatment consists of 1–3 cycles, there are 5–12 daily procedures in each cycle. The interval between the cycles is 12–14 days [Britova A.A., 1992].

ILBI in the complex treatment of patients with severe generalized periodontitis can significantly reduce the treatment period (by up to 7–10 days), the remission periods increase considerably – by up to 1.5–2 years [Danilevskiy N.F. et al., 1989]. With severe ulcerous-necrotic stomatitis the treatment period is 6–7 days less, a good analgesic effect is observed, the epithelialization is accelerated, the body temperature is normalized and the general condition of the patients improves faster [Danilevskiy N.F. et al., 1989⁽¹⁾].

ILBI technique (Table 5 or 6), there are 5–7 daily procedures per course.

Combined EHF-low level laser therapy [Brekhov E.I. et al., 2007; Moskvina S.V., Ponomarenko G.N., 2016; Moskvina S.V., Khadartsev A.A., 2016], laser-vacuum massage [Amirkhanyan A.N., Moskvina S.V., 2005; Moskvina S.V., Ponomarenko G.N., 2016] and laser phoresis of different drugs [Moskvina S.V., Konchugova T.V., 2012; Moskvina S.V. et al., 2014] show good clinical results.

Purulent Infection Processes of Maxillofacial Area, Phlegmons

With pyo-infectious complications of facial fractures, ILBI brings the carbohydrate metabolism indicators to normal, improves the energy status of the peripheral blood erythrocytes and the structural and functional properties of their membranes. LLLT is accompanied by the immunomodulatory effect, firstly influencing the T-system of immunity and a reduction of resistance of microbial flora to antibiotics occurs [Lepilin A.V., 1995].

ILBI technique (Table 5 or 6), there are 5–7 daily procedures per course.

Benign Migratory Glossitis

The choice of the laser exposure zone is defined by the pain localization (lateral and dorsal surfaces, tip of the tongue, etc.). As a general rule, the intraoral scanning technique is implemented, 5 affected zones during one procedure. The KLO-635-15 laser head (wavelength is 635nm, continuous mode, maximum power is 10–15mW), the procedure time is 4–5 minutes.

Mandibular Fracture

The technique is contact-mirror, stable with the LO-904-20 pulsed IR laser head and the ZN-35 mirror nozzle (wavelength is 904nm, power is 10–15W, frequency is 80–150Hz). The external illumination of a fracture area is implemented for five minutes, of zones 1 and 4 for 1.5–2 minutes (Fig. 51). In 2 weeks the course is repeated.

Periodontitis

It is proved that the exposure to continuous LILI of the red spectrum (635nm) directly through a root canal has an anti-inflammatory effect and reduces the virulence of pathogens, which creates optimal conditions to restore the damaged periodontal tissues [Gimaeva L.A., 1990], and contributes to helping restore the supporting function of the teeth [Klyushnikova O.N., 1992].

Low level laser therapy is implemented with the help of the appropriate stomatology nozzle from the S-1 set, directly into a canal orifice with the KLO-635-15 laser head (wavelength is 635nm, continuous mode, maximum power is 10–15mW). The technique is contact intraoral. There are 3–5 procedures per course.

Periostitis, Enamel Hyperesthesia, Postoperative and Traumatic Oral Tissue Injury

The illumination of a damaged area is implemented with the help of stomatology nozzles from the S-1 set with the KLO-635-15 laser head (wavelength is 635nm, continuous mode, maximum power is 10–15mW), for 1.5–2 minutes on one zone.

Additionally, the exposure along the maxilla and mandible (Fig. 52) in the area of the projection of the affected zone is implemented (the number of fields can be up to 6). The technique is contact-mirror, stable with the LO-904-20 pulsed IR laser head and the ZN-35 mirror nozzle (wavelength is 904nm, power is 10–15W, frequency is 80–150Hz), for 1.5–2 minutes on a zone. The procedure time is 10–12 minutes. The second course is implemented in 4–8 weeks, if necessary.

With traumas the preliminary mechanical and antiseptic debridement of the focus is implemented. When traumas are extensive, the scanning illumination technique is implemented for five minutes, the mouth is open, a laser head (it can be IR, as well as of the red spectrum) is set up at the level of the front teeth.

Replantation

LLLT technique is contact-mirror, stable with the LO-904-20 pulsed IR laser head and the ZN-35 mirror nozzle (wavelength is 904nm, power is 10–15W, frequency is 80–150Hz), for 1.5–2 minutes on zones 1, 4 and on the projections of the damaged tissue zone (Fig. 51).

If possible, it is better to implement the intraoral illumination with the use of stomatology nozzles from the S-1 set according to the stable technique. The parameters of the technique are the same as with the external illumination.

Sialoadenitis

LLLT technique is contact-mirror, stable with the LO-904-20 pulsed IR laser head and the ZN-35 mirror nozzle (wavelength is 904nm, power is 10–15W, frequency is 80–150Hz), for 1.5–2 minutes on zones 1, 2, 3 and 4 (Fig. 51), and through the mouth with the help of the S-1 stomatology nozzles (the gap is 0.5–1cm). The technique is stable, distant.

Melkersson-Rosenthal Syndrome

LLLT technique is contact-mirror, stable with the LO-904-20 pulsed IR laser head and the ZN-35 mirror nozzle (wavelength is 904nm, power is 10–15W, frequency is 80–150Hz), for 1.5–2 minutes on zones 1, 2, and 3 (Fig. 51) and on the lesions in the lip area for five minutes.

Urology

Amyloidosis

ILBI technique (Table 5 or 6), there are 10–12 daily procedures per course.

Repeated courses of low level laser therapy are implemented in 6 and 12 months. Then repeated low level laser therapy courses are implemented every 12 months over a period no less than 5 years [Lutoshkin M.B., 2003].

Infertility

LLLT technique is contact, stable with the ML-904-80 matrix pulsed IR laser head and the MM-50 magnet nozzle (wavelength is 904nm,

maximum power is 60–80W, frequency is 80–150Hz), successively on the sacrum and perineum regions for two minutes on each zone. There are up to 10 procedures per course.

ILBI technique (Table 5 or 6), there are 7–10 daily procedures per course.

Glomerulonephritis

ILBI technique (Table 5 or 6), there are 10–12 daily procedures per course.

The course of treatment consists of 10–12 procedures. Repeated courses are implemented in 3–6–9 months to secure the result, or prophylactically [Lutoshkin M.B., 2003].

Diabetic Nephropathy

ILBI technique (Table 5 or 6), the first 5 procedures.

During the next 5–7 procedures the projections of the kidneys are exposed symmetrically, the technique is contact, stable with the ML-904-80 matrix pulsed IR laser head and the MM-50 magnet nozzle (wavelength is 904nm, maximum power is 60–80W, frequency is 80–150Hz), for 2–5 minutes on each side.

Repeated courses are implemented in 3 and 6 months. Then a low level laser therapy course must be implemented once a year over the course of 5–10 years.

All patients receive complex therapy according to the underlying disease – diabetes – taking into account, the type, option and severity of the underlying disease.

The LLLT sessions improve the patients' quality of life, reducing and blunting the clinical manifestations of uremic intoxication and diabetes itself – polyneuropathy, angiopathy, itching, dyspepsia. The available data clearly indicates the overall positive effect of LILI on the renal function of diabetic patients with diabetic nephropathy development [Lutoshkin M.B., 2003].

Complications after Extracorporeal Lithotripsy

Our data indicates a pronounced therapeutic effect of LLLT on the process of the discharge of concretions from the urinary tract after distant shockwave lithotripsy in comparison with other traditionally applied

therapeutic methods. The application of the ML01K matrix pulsed laser head has turned out to be the most effective [Khalyastova E.A., Moskvina S.V., 2002].

The LLLT technique is contact, stable with the ML-904-80 matrix pulsed IR laser head and the MM-50 magnet nozzle (wavelength is 904nm, maximum power is 60–80W, frequency is 1000–1500Hz). During the first 24 hours the projection is of the concretion or the “stone path”, the projection of the ureter segment located below the stone is exposed; on the 2nd day the same points and the projection of the kidney are exposed; on the 3rd and the following days – all the 3 fields are exposed. The exposure on each zone is five minutes. The course consists of 8–10 daily procedures. Antispasmodics, analgesics and antibiotics are prescribed to all the patients to prevent the development of inflammatory complications [Khalyastova E.A., Moskvina S.V., 2002].

Low Level Laser Therapy during Hemodialysis and after Kidney Transplantation

Low level laser therapy of patients with terminal renal failure after the program of hemodialysis treatment leads to a 55–60% reduction of the development of complications, to the decrease of the total peripheral resistance and heart function improvement, to a significant decrease of triglycerides, prebetalipoproteids, cholesterol, to the normalization of lipid peroxidation, to the improvement of the indicators of the activity of redox processes, to the microcirculation improving connected with the capillary expansion and to the improvement of the rheological blood parameters according to the coagulogram data. A smoother course of uremic pericarditis is observed, mortality is reduced, the disease duration with pyo-septic complications is reduced, their resolution is faster than in the control group, due to the endogenous intoxication reduction (urea level, creatinine level, middle molecules) and with the elimination of the state of immunological paralysis as a result of the expressed immunosuppressive therapy in connection with the crises of rejection of the transplanted kidney [Zakharov V.V. et al., 1995; Lebedkov Ye.V., 1996; Lutoshkin M.B., 2003; Sernyak P.S. et al., 1995].

ILBI technique (Table 5 or 6), there are 10–12 daily procedures per course.

Urolithiasis

Low level laser therapy with renal colic is implemented by the scanning mode on the zones of the projection of the ureter below the stone localization, on the stone projection, on the kidney projection by two fields, every day until the concretion comes out from the urinary tract. The technique is contact, stable with the ML-904-80 matrix pulsed IR laser head and the MM-50 magnet nozzle (wavelength is 904nm, power maximum is 60–80W, frequency is 1000–1500Hz), for five minutes on each zone [Avdoshin V.P., 2000].

LLLT for patients with urate nephrolithiasis is justified by the stabilizing effect of LILI on the membranes, leading to the normalization of the colloidal systems. The normalization of the uric acid indicators in the blood serum is achieved on the 5th day of treatment. LLLT, as a part of the complex therapy aimed at the prevention of lithogenesis recurrence, is pathogenetically justified and reasonable. This treatment considerably reduces the recurrence rate in this category of patients. The technique is contact, stable with the ML-904-80 matrix pulsed IR laser head and the MM-50 magnet nozzle (wavelength is 904nm, maximum power is 60–80W, frequency is 1000–1500Hz), on the area of kidneys – for five minutes symmetrically, there are 8–12 procedures per course. Preventive courses are repeated every 3 months [Avdoshin V.P., 2000].

In the preoperative period, the exposure is percutaneous (Fig. 53) parasternal (zones 1) at the level of the second intercostals space, then on the inguinal vascular bundles (zones 4) for 2 minutes on each zone and the area of the stone projection in the back and in the front (zones 2, 3) for five minutes on each – laser heads are slowly being moved down in the zone which is 12–15cm long. In 4–6 hours the exposure is repeated. The technique is contact, with the ML-904-80 matrix pulsed IR laser head and the MM-50 magnet nozzle (wavelength is 904nm, maximum power is 60–80W, frequency is 1000–1500Hz). In many cases, the LLLT implemented according to this scheme paired with excessive drinking and medication (antispasmodics, analgesics, etc.) contributes to stone passage and surgery cancellation.

After a stone passage (or in the postoperative period) low level laser therapy is implemented every day for 5–7 days, 1–2 times a day. The exposure on the area of a damaged kidney (zone 3) and on the inguinal

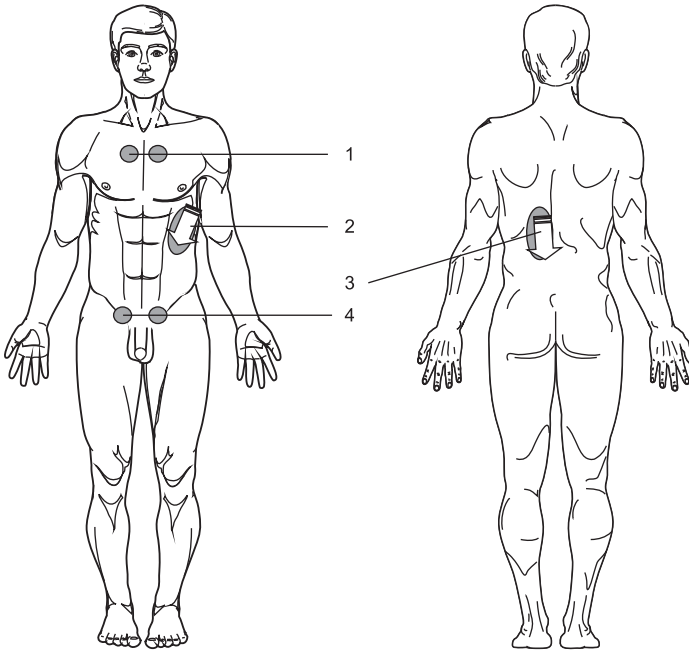

Fig. 53. Exposure technique for urolithiasis

vascular bundles (zones 4) is for two minutes on a zone. IR LILI pulse repetition frequency is increased to 600Hz.

Acute Pyelonephritis

LLLT (external into the projection of the kidneys) improves microcirculation in the parenchyma of a damaged kidney and is recommended for all the variants of the disease; ILBI is recommended with a pronounced suppression of cellular and humoral immunity; a combined technique is recommended with pyo-septic kidney diseases with severe intoxication.

LLLT technique is contact, with the ML-904-80 matrix pulsed IR laser head and the MM-50 magnet nozzle (wavelength is 904nm, maximum power is 60–80W, frequency is 1500–3000Hz), successively on the projections of the kidneys for five minutes on a zone. The number of procedures should be no more than 10, every day or every other day.

ILBI technique (Table 5 or 6), there are 7–10 daily procedures per course [Moskvin S.V. et al., 2004; Ivanchenko L.P. et al., 2009].

Acute and Chronic Cystitis

LLLT is implemented simultaneously with the ML-904-80 matrix pulsed IR laser head and the MM-50 magnet nozzle (wavelength is 904nm, maximum power is 60–80W, frequency is 80–150Hz) and with the LO-904-20 pulsed IR laser head and the ZN-35 mirror nozzle (wavelength is 904nm, power is 10–15W, frequency is 80–150Hz), in pairs on the area of the projection of the bladder (zone 6), on the spinous process L_v (zone 4), on the kidneys (zone 2), on the inguinal vascular bundles (zone 5) and zones 1 and 3 (Fig. 54). The number of procedures is no less than 5–7. As a rule, after the 2nd–3rd session, urination is normalized, the dysuria disappears.

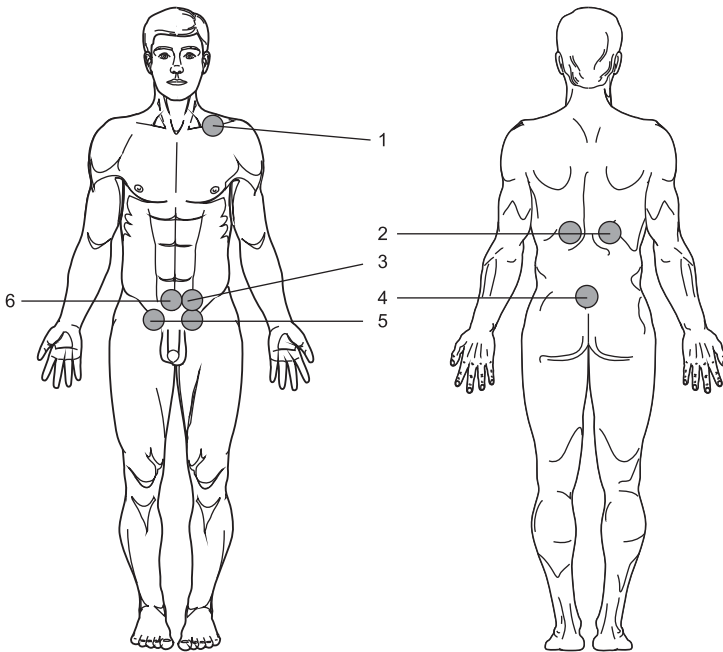

Fig. 54. Exposure technique for cystitis

When acute cystitis is combined with inflammatory diseases of the genitals, successive illumination of the projection of the bladder and uterine appendages is implemented with the ML-904-80 matrix pulsed

IR laser head and the MM-50 magnet nozzle (wavelength is 904nm, maximum power is 60–80W, frequency is 80–150Hz) and simultaneously with the LO-904-20 pulsed IR laser head and the ZN-35 mirror nozzle (wavelength is 904nm, power is 10–15W, frequency is 80–150Hz) with the help of G-2 nozzle intravaginally for five minutes on each area, and there are no less than 5–7 procedures per course.

Chronic cystitis needs longer treatment, which must include instillations of various antiseptics into the bladder together with conventional antibiotic therapy. Laser exposure is implemented on the projection of the bladder in the suprapubic region with the ML-904-80 matrix pulsed IR laser head and the MM-50 magnet nozzle (wavelength is 904nm, power maximum is 60–80W), frequency is 80–150Hz during the first 3 sessions and the 7–10th sessions, frequency is 3000Hz during the 4–6th sessions, and the exposure is five minutes. In special cases, the LLLT course can be repeated offline (without any other types of treatment), 10 days after the end of the first course.

Postoperative Sutures

Low level laser therapy is efficient in the treatment of patient's post-surgery, after reconstructive surgery on the ureter, urethra and vesicovaginal fistulae surgery, plastic surgery connected with urinary incontinence. Low level laser therapy can reduce the healing time and the risk of complication development.

LLLT technique is stable, distant with the ML-904-80 matrix pulsed IR laser head and the MM-50 magnet nozzle (wavelength is 904nm, maximum power is 60–80W, frequency is 80–150Hz), on the area of the incision in 2–3 zones for 0.5–1 minutes on a zone. If necessary, the course is repeated in 4–5 days.

Prostatitis

Due to the multicomponent and multilevel effect of LILI, to the metabolism and blood circulation normalization, the complex treatment of urological diseases with the help of LILI is accompanied by the increase of the efficiency of all therapeutic measures. A considerable improvement of the lymph and blood circulation in the area of laser exposure causes a more efficient delivery of antibiotics into the prostate, which allows doctors to reduce the number and dosage of drugs.

Low level laser therapy is an additional means in the sub-acute and chronic periods of the disease contributing to the lesion sanitation, and mobilizing the sanogenetic mechanisms of the body. The achievement of high therapeutic results, treatment time reduction, elimination of a patient's overloading on medication can be ensured by the simple organizational and treatment condition compliance. These conditions are: a rational diet, an individual rhythm of work and rest, physiotherapy, a sexual hygiene rule compliance, normalization of the function of the organs taking part in hormonopoiesis, sedatives. If neuropsychiatric symptoms occur, then the elimination of potential sources of infection. The treatment of patients with latent trichomoniasis, tuberculosis and other infectious diseases of the prostate is implemented alongside specific medication and immunological control.

Technique 1. Intracavitary. The exposure is implemented through the P-2 rectal nozzle, which is inserted into the rectum, on the projection of the prostate (Fig. 55). This laser exposure option can effectively eliminate the inflammation in the prostate and improve the blood flow in the tissues in the exposed zone. The technique is recommended during the first procedures, especially with advanced forms of chronic prostatitis, as well as during the course of antibacterial therapy. The KLO-635-15 continuous laser head of the red spectrum can be used (wavelength is 635nm, maximum power is 10–15mW, modulated mode with frequency of 10Hz is often used), but it is more preferable to use the LO-904-100 pulsed IR laser head (wavelength is 904nm, power is from 20 to 100W)

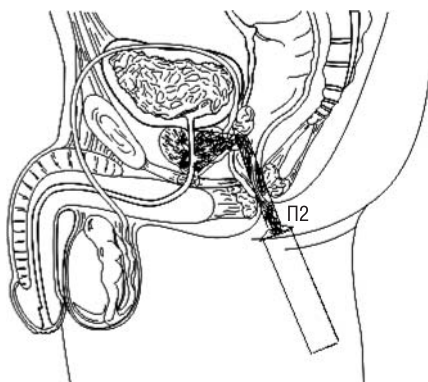

Fig. 55. Intrarectal low level laser therapy for prostatitis

or the LO-635-5 pulsed red laser head (wavelength is 635nm, maximum power is 5W), as it is possible to get different results by alternating the frequency of pulsed heads from 80 to 10,000Hz, for example, to get an anti-inflammatory effect (low frequencies), or anesthesia (high frequencies).

Technique 2. External, the exposure on the prostate is percutaneous (Fig. 56). The technique is stable, contact with the ML-904-80 matrix pulsed IR laser head and the MM-50 magnet nozzle (wavelength is 904nm, maximum power is 60–80W, frequency is alternated from 80 to 10,000Hz),

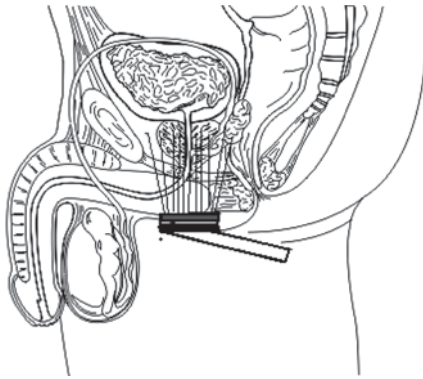

Fig. 56. Percutaneous low level laser therapy for prostatitis

Technique 3. “BIO” mode. In this mode the coincidence of the phase of stimulation of the small pelvic and perineum muscles (1st and 2nd variants) with the pulse wave phase and modulation frequency of about 10Hz is an additional factor which improves the functions of the micro-circulatory bloodstream most affected by abnormalities. This mode is recommended in the three final procedures of the low level laser therapy course to normalize the functioning of the prostate and central (system) regulatory mechanisms.

Low level laser therapy is implemented with a partially filled bladder (for further mechanical evacuation of the prostate secretion with urine). A patient is in an urogynecological chair in the supine position, thus, the muscles of the lower half of the trunk and the lower limbs are relaxed.

The exposure by laser illumination is intrarectal (Fig. 55) and/or transdermal on the perineum (the area between the scrotum and anus) through one layer of the gauze cloth (Fig. 56).

Vibromagnetic laser massage technique.

It is known, that a prostate massage improves circulation and reduces phlebostasis, contributes not only to the rush of arterial blood in the prostate tissue, thus improving its trophism, but also to the elimination of stagnant secretion and to the acini release, causing the occluded ducts drainage and antibiotic access facilitation. It is successfully applied to create the necessary outflow of pathological products contained in the secretion of the dilated acini with the congestive form of chronic prostatitis.

Vibromagnetic laser prostate massage tactics depends upon the nature of the disease, its duration, the condition of the abdominal and pelvic floor muscles, the cardiovascular system function, a patient's age and his working and living conditions.

The vibromagnetic laser prostate massage can be implemented not only to treat, but to also prevent the disease from occurring, as well as to increase male potency and to cure male infertility.

Contraindications to this procedure are acute prostatitis, exacerbation of common infections and purulent diseases, body temperature increase and exacerbation of chronic prostatitis and gleet, tuberculosis of genitals, cancer and stones of the prostate, anal fissures, proctitis, paraproctitis, aggravation of hemorrhoid and acute infections.

The vibromagnetic laser massage should be included into the general low level laser therapy scheme described above. The procedures are implemented every day with a partially filled bladder, the *bladder must be discharged immediately after each procedure*. A patient is in a urogynecological chair in the supine position. A condom is put on a nozzle; the exposure is implemented through the rectal ampoule mucous.

Procedures 1–5 are implemented with LILI only, without vibration, exposure is five minutes, laser illumination modulation frequency is 10Hz.

Procedures 6–10 are implemented with the switched on vibration and LILI, exposure is five minutes, modulation frequency is 10Hz, vibration frequency is 3Hz, the amplitude is 20%. Vibromagnetic laser massage is implemented only if a patient does not have any feelings of pain. Otherwise, the doctor varies the vibration amplitude.

Procedures 10–15 are implemented with the use of a vibromassage only, without laser illumination, exposure is five minutes, vibration frequency is 8–10Hz. The maximum vibration amplitude is up to 60%, under the control of a patient's subjective assessment.

Our numerous studies have shown the high efficiency of this technique in the complex treatment of patients with chronic bacterial prostatitis, which increases the effectiveness of treatment due to the combined effect of antibacterial drugs, bacteriostatic and immunomodulatory effects of the physical factors applied, due to the recovery and normalization of microcirculation in the prostate area and the improvement of drainage function of the prostate ducts. The efficiency of treatment can be up to 92%. [Zakharova M.P., 2014; Ivanchenko L.P. et al., 2009; Moskvina S.V. et al., 2004; Mufaged M.L. et al., 2007; Sosnovskiy I.B., 2012].

Traumatic Ureteral Fistulas

Secondary stenoses in the place of the implantation of the ureters can often occur after plastic surgery on the lower third of the ureter: there is inflammation in the zone of the anastomosis and surrounding tissues that leads to prolonged anastomoses due to a club-shaped swelling and post-operative trauma. The so-called irritable bladder is quite often formed.

Low level laser therapy begins on the first day after the surgery and is implemented every day. The technique is stable, contact with the ML-904-80 matrix pulsed IR laser head and the MM-50 magnet nozzle (wavelength is 904nm, maximum power is 60–80W, frequency is 80–150Hz), for 1.5–2 minutes on areas 3, 4 and 5 (Fig. 53).

Urogenital Infections, Urethritis

The treatment is implemented alongside standard antimicrobial therapy.

ILBI technique (Table 5 or 6), there are 15 daily procedures per course.

The technique is contact, stable with the ML-904-80 matrix pulsed IR laser head and the MM-50 magnet nozzle (wavelength is 904nm, maximum power is 60–80W, frequency is alternated from 80 to 10,000Hz), on the painful points (hepatobiliary, lumbosacral areas, the area of the thyroid and thymus), on the area of the projection of the appendages or penis, the exposure is 1.5–2 minutes on a zone, there are 7–10 procedures per course.

Intracavitary technique, the exposure is implemented through the U-1 urethral nozzle, which is input into the urethra to the sphincter, moving outwards from the sphincter with the KLO-635-15 continuous laser head of the red spectrum (wavelength is 635nm, maximum power is 10–15mW, modulated mode with frequency of 10Hz) and with the LO-904-20 pulsed IR laser head (wavelength is 904nm, maximum power is 15–20W, frequency is 80–150Hz). There are 10–15 procedures per course.

Fibroplastic Induration of the Penis (Peyronie's Disease)

Low level laser therapy is combined with the alfa-2b interferon injection. Interferon is injected 2 times a week, the dosage is from 1 to 3 million IU. It is injected under the plaque during the first 1–2 weeks, then directly into the plaque. The patients are questioned about side effects before each repeated injection. The course scheme of interferon therapy is worked out individually for each patient in accordance to their deficiency of endogenous interferon alpha, and the dosage is from 15 to 40 million IU. The normalization of the indicators of the interferon status in the course of treatment is a reason to cancel the injections [Ivanchenko L.P. et al., 2003].

Laser illumination is implemented by contact, stable method, every day, once a day with the KLO-635-15 continuous laser head of the red spectrum (wavelength is 635nm, maximum power is 10–15mW, modulated mode with frequency of 10Hz or “BIO”) the total procedure time is 15 minutes. The course duration is 12–15 procedures.

Chronic Kidney Disease

ILBI technique (Table 5 or 6), there are 10–12 daily procedures per course.

Repeated courses of low level laser therapy are implemented in six and 12 months. Then repeated courses are implemented every 6–12 months during a period of 5–10 years [Lutoshkin M.B., 2003].

Chronic Pyelonephritis

Low level laser therapy is implemented as a part of the complex treatment consisting of antibacterial therapy, detoxifying agents, immunomodulators, cardiovascular drugs and antihypertensives. LILI exposure

contributes to the increase in the concentration of drugs in the inflammatory focus and potentiation of their effect [Andryukhin M.I. et al., 1992].

A pronounced positive effect of LILI application in the complex treatment of patients with the exacerbation of chronic pyelonephritis has been shown. Positive dynamics of some clinical and laboratory signs of acceleration of the relief of the inflammatory process in the body is observed together with the reduction of the period of patients' stay in hospital, after the first and repeated preventive courses of LLLT, the exacerbations of pyelonephritis are much less [Lutoshkin M.B., 2003].

LLLT course consists of 12–14 daily procedures. During the first 5–6 procedures, ILBI (Table 5 or 6) is implemented, then the external illumination of the area of the projection of the kidneys is implemented for five minutes on a zone. The technique is stable, contact with the ML-904-80 matrix pulsed IR laser head and the MM-50 magnet nozzle (wavelength is 904nm, maximum power is 60–80W, frequency is 1500–3000Hz). During one session, 2–3 zones along the anterior, midaxillary and posterior axillary lines are exposed. A patient is lying on his/her side with a padded roller. It is preferable to use two laser heads at the same time.

If patients have arterial hypertension syndrome, additional illumination is implemented on the zones located paravertebrally at C_{III}–Th_{III} level on the right and on the left with two laser heads simultaneously. The technique is contact-mirror, stable with the LO-904-20 pulsed IR laser head and the ZN-35 mirror nozzle (wavelength is 904nm, power is 10–15W, frequency is 80–150Hz), for one minute on each zone. The course of low level laser therapy is repeated in two months, and the third course is implemented in three months after the second course, then a preventive course is implemented every year [Lutoshkin M.B., 2003].

Surgery

Low level laser therapy contributes to the faster healing of damaged tissues, it considerably reduces (10–12 times less) the possibility of postoperative complications, the treatment time is reduced, a patient's ability to work is restored faster.

The main tasks of low level laser therapy in the postoperative period are to improve a patient's general condition, to prevent stagnation caused

by a patient staying in bed, to stimulate the repair processes in injured tissues, to eliminate or reduce pain syndromes, to normalize trophisms and prevent contracture formation.

Anesthesiology

The inclusion of ILBI in the complex of anaesthesia measures aimed at a patient's protection from surgical stress increases their level, which is confirmed by lower sugar content in a patient's blood at the stages of surgical intervention under using less anesthetics and narcotic analgesics. ILBI also contributes to faster restoration of stress affected tissue metabolism [Avrutsky M.Ya. et al., 1997].

ILBI-635 technique (Table 6). The procedure time is 30 minutes for the three procedures: the first – 10 minutes before the anesthesia input, the second – during the most traumatic surgery phase, the third – 30 minutes before the supposed end of surgery [Avrutsky M.Ya. et al., 1997].

Hemorrhoids

In the course of low level laser therapy, it is necessary to make sure that the ampoule of the rectum is empty before the procedure.

LLLT technique is stable, contact with the ML-904-80 matrix pulsed IR laser head and the MM-50 magnet nozzle (wavelength is 904nm, maximum power is 60–80W, frequency is 80–150Hz), in the projection of the anus, the exposure is 2–5 minutes. The option of the intracavitary technique with the LO-904-20 pulsed IR laser head with the P-3 rectal nozzle (wavelength is 904nm, power is 10–15W, frequency is 80–150Hz), the exposure is 2–5 minutes. There are 5–7 daily procedures per course.

Pyoinflammatory Diseases

ILBI in the treatment of pyoinflammatory diseases contributes to the antioxidant defense system normalization, has immunomodulatory and anti-inflammatory effect, intoxication and bacterial contamination of wounds are reduced, and the healing processes are accelerated [Erzhanov O.N., 1993].

ILBI technique (Table 5 or 6), there are 5–7 daily procedures per course.

Purulo-Necrotic Complications of Diabetic Patients

All forms of diabetes with purulent necrotic infections can be the indications for ILBI. The combined application of ILBI with hemosorbition with the use of activated carbon has a pronounced detoxifying effect. LLLT contributes to a smoother postoperative course, earlier (10–12 days less) wound healing, a 1.8–2 time reduction of the “stay in bed” period [Lebedkov Ye.V., 1996].

ILBI technique (Table 5 or 6), there are 5–7 daily procedures per course.

Lymphadenitis

Before the low level laser therapy prescription, it is necessary to define the nature of the process. In the stage of increasing and thickening of the lymph nodes (submandibular, cervical, axillary, inguinal, etc.) the zones of pain and thickening are exposed directly.

LLLT technique is stable, contact with the ML-904-80 matrix pulsed IR laser head and the MM-50 magnet nozzle (wavelength is 904nm, maximum power is 60–80W, frequency is 80–150Hz), into the lymph nodes, the exposure is 2–5 minutes on one zone. There are 10–12 daily procedures per course.

Burns and Frostbites

Low level laser therapy *is recommended* with exudative inflammation syndrome of singes; for the prevention of the deepening and the stimulation of reparative processes in wounds with subdermal burns; for the improvement of blood circulation and lymphokinesis in the paranecrotic zone and for the stimulation of the full granulation cover formation during the preoperative period with deep burns, and during the postoperative period – for the stimulation of the regenerative processes; for the prevention and treatment of pneumonia and the relief of secondary immune deficiency.

Low level laser therapy is *contraindicated*: for the patients having extensive deep burns and unfavorable or doubtful prognosis during the period of burn shock; for the patients with acute respiratory failure, acute renal hepatic failure; acute cerebral circulation disorder; uncompensated diabetes, acute alcohol intoxication delirium and epilepsy.

The illumination is implemented in the early stages of a burn trauma, on the open wound surface, distantly (at the distance of 5–6 mm from the

wound surface) or through bandages, with the LO-904-20 pulsed IR laser head (wavelength is 904nm, power is 10–15W, frequency is 80–150Hz), the exposure on one point is eight seconds – until necrosis rejection, four seconds – after its removal. The exposure is implemented on 3–4 points of 1% of the area, the procedure time is up to six minutes (up to 35 points can be exposed during one procedure). If necrosis occurs, the treatment course is five procedures, during the preoperative period (on the open wound) – five procedures, during the postoperative period (during bandaging or through the bandage) – in accordance with the indications, but not more than five procedures [Gerasimova L.I., 2000].

ILBI technique (Table 5 or 6), there are 5–7 daily procedures per course.

Bone Fractures

Low level laser therapy can be implemented immediately after the trauma and during all the stages of the process of treatment. Metal synthesis does not interfere with low level laser therapy procedures. If a damaged patient's limb is in plaster bandage, a hole is cut in it.

LLLT technique is stable, contact with ML-904-80 matrix pulsed IR laser emitting head with MM-50 magnet nozzle (wavelength is 904nm, power maximum is 60–80W, frequency is 80–150Hz), the exposure is five minutes. If necessary, the exposure is implemented through the plaster (the contact exposure on the fracture projection in 4 points; the parameters are the same as with the exposure through a window).

Low level laser therapy contributes to the acceleration of the callus formation, as a result, an earlier application of exercise stress is possible. The treatment efficiency is assessed by an X-ray. The fracture line is examined by an X-ray for four months (2–3 months faster than with conventional treatment).

Peritonitis

The most significant therapeutic effect in patients with localized and generalized forms of peritonitis is achieved by the use of the combined method of treatment: antibiotic lavage of the abdominal cavity, and low level laser therapy – in the postoperative period.

LLLT technique is stable, contact with the ML-904-80 matrix pulsed IR laser head and the MM-50 magnet nozzle (wavelength is 904nm, maximum power is 60–80W, frequency is 80–150Hz), for 1.5–2 minutes on

a zone, through the abdominal wall (Fig. 57, zones 3–6), on the projection of the femoral vessels (zones 7, 8), on the projection of the thymus (zone 2) and the left subclavian vascular bundle (zone 1). There are 3–7 daily procedures per course.

ILBI technique (Table 5 or 6), there are 5–7 daily procedures per course.

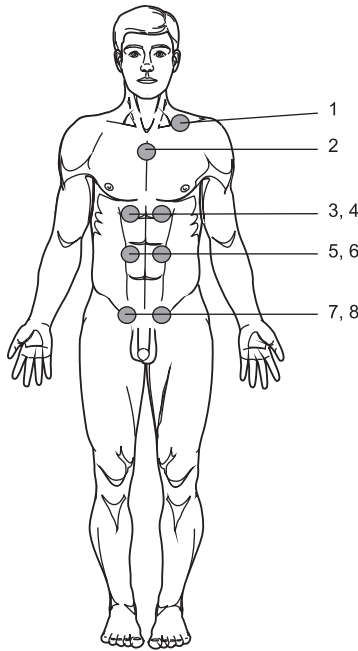

Fig. 57. Exposed zones for peritonitis

Postoperative Complications

Ulcers, Postoperative Suppuration, Pressure Ulcers

Laser exposure is implemented after the toilet of the affected area, distant at the distance of 0.5–1cm (stable or labile) with the ML-904-80 matrix pulsed IR laser head and the MM-50 magnet nozzle (wavelength is 904nm, maximum power is 60–80W, frequency is 80–150Hz), for 1.5–2 minutes on a zone. There are 3–5 daily procedures per course.

ILBI technique (Table 5 or 6), there are 5–7 daily procedures per course.

Postoperative Pareses, Intestinal Obstruction

Low level laser therapy can be implemented on the second day after the surgery. Patients with functional disorders of the motor activity of the intestine (flatulence, atony, constipation), calcium deficiency, as well as elderly and senium patients should undergo low level laser therapy procedures 2–3 days before the surgery for prophylactic purposes [Buylin V.A., 1990].

The technique is contact-mirror, labile with the LO-904-20 pulsed IR laser head and the ZN-35 mirror nozzle (wavelength is 904nm, power is 10–15W, frequency is 80–150Hz), on the abdominal wall by spiral motions, 1–2 passages along line 1) for 4–6 minutes along the colon from the zone of the projection of the cecum to the sigmoid colon (Fig. 58). The procedure must be repeated in 4 hours. The course of treatment is

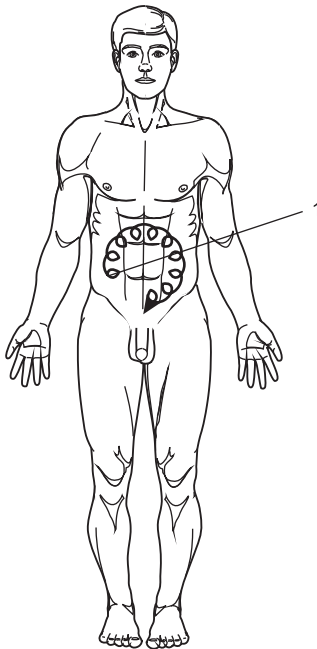

Fig. 58. Low level laser therapy technique for postoperative enteroparesis

2–3 days (4–6 procedures). The exposure can be implemented through a bandage; the laser head pressure (the mirror nozzle pressure) on the skin surface must not cause any pain.

Laser acupuncture (Table 4), modulated mode, frequency is 2.4Hz. The exposure on one point is 25–30 seconds, successively on the points (symmetrically): GI4, E25, E36, RP1, RP4, RP6, MC6, the exposure is finished with asymmetrical point VC12 (“basic recipe”, Fig. 11). The procedure is implemented in the first half of the day at the same time. The motor activity of the intestine is usually restored after two procedures.

This technique is also efficient with motor intestinal disorders of therapeutic, cardiac patients, etc.

ILBI technique (Table 5 or 6), there are 5–7 daily procedures per course.

Wounds (Home, Sports, Gunshot)

The wound toilet or debridement are necessary.

LLLT technique is stable, contact with the ML-904-80 matrix pulsed IR laser head with MM-50 magnet nozzle (wavelength is 904nm, maximum power is 60–80W, frequency is 80–150Hz), on zones 1–4 (Fig. 59), and distant, at the distance of 5–15cm, for the light spot to overlap the wound area (Fig. 59). The exposure time is gradually increased from 0.5 minute during the first procedure to five minutes by the 10th procedure.

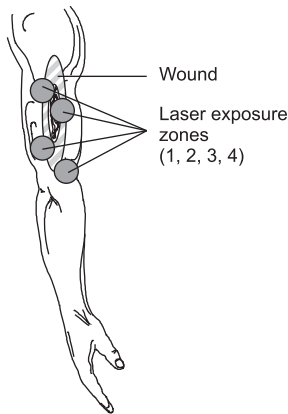

Fig. 59. Exposed zones on the wounds

With *slow healing wounds* LLLT is implemented by courses of 10 daily procedures with 2-week breaks (2–3 courses). The exposure on the wound area is distant, stable on the fields or labile (scanning), trying to overlap the wound maximally. It is efficient to combine the exposure with the ML-904-80 matrix pulsed IR laser head (wavelength is 904nm, maximum power is 60–80W, frequency is 80–150Hz) for 1.5 minutes, with the interval of 1.5 minutes, with the ML-635-40 matrix pulsed red laser head (wavelength is 635nm, maximum power is 40W, frequency is 80–150Hz), also for 1.5 minutes.

ILBI technique (Table 5 or 6), there are 5–7 daily procedures per course.

Festering wounds, phlegmons, abscesses, mastitis, felons. LLLT is implemented after the surgical opening of the purulent focus in the complex with medication, enzymatic bandages and other bandages. After the wound toilet, the exposure is implemented through 2–3 layers of gauze in a stable manner on 2–4 fields (depending upon the wound area). It is possible to implement the exposure through a bandage. LLLT technique is stable, contact with the ML-904-80 matrix pulsed IR laser emitting head and the MM-50 magnet nozzle (wavelength is 904nm, maximum power is 60–80W, frequency is 80–150Hz), the exposure time is 2–5 minutes.

ILBI technique (Table 5 or 6), there are 5–7 daily procedures per course.

Rehabilitation after Chemical Peelings, Laser Resurfacing

Low level laser therapy is implemented to stimulate the repair processes, to remove a postoperative swelling (lymphostasis) and to eliminate inflammation. Laser illumination has an anesthetic and bacteriostatic effect.

Low level laser therapy is recommended after superficial peelings beginning with the 2nd day, with median peelings – with the 5th day, with deep peelings and laser resurfacings – with the 7th day after manipulations [Geynits A.V., Moskvin S.V., 2010].

Technique 1. Labile, distant with a gap of 0.5–1cm from the tissues, with the KLO-635-15 laser head (wavelength is 635nm, maximum power is 10–15mW, modulated mode, frequency is 10Hz). The total time of the exposure is five minutes, successively: the forehead, nose, cheeks, chin.

Technique 2. Paravertebrally. The technique is contact-mirror, stable with the LO-904-20 pulsed IR laser head and the ZN-35 mirror nozzle

(wavelength is 904nm, power is 10–15W, frequency is 80–150Hz), on C_I–C_{VI}, segments, for one minute on a zone.

Additionally: the point of the vertebral artery (on the line connecting the mastoid of the 1st cervical vertebra with the mastoid in the outer third of this line), output power is 5–7W, frequency is 80–150Hz, the technique is contact-mirror, stable, the exposure time is 1.5–2 minutes.

Syndrome of Disseminated Intravascular Coagulation (DIC)

When significant blood loss during surgery occurs, ILBI prevents DIC-syndrome development, normalizes blood rheology, the main hemostasis indicators are aligned by the 5th day after the surgery, the possibility of the bleeding resumption from the stitched wounds is eliminated [Koshelev V.N. et al., 1995].

ILBI technique (Table 5 or 6), there are 5–7 daily procedures per course.

Anal Fissure

During the first 3–5 procedures it is reasonable to implement low level laser therapy according to the external distant technique on the zone of the anus opening (the distance from the laser emitting head to the skin surface is 1cm) with the ML-904-80 matrix pulsed IR laser head and the MM-50 magnet nozzle (wavelength is 904nm, maximum power is 60–80W, frequency is 80–150Hz), the exposure is two minutes. Then the exposure is intracavitary (with the help of the P-3 nozzle) through the anus opening for two minutes too (the total time of the procedure is 4–5 minutes) with the KLO-635-15 laser head (wavelength is 635nm, maximum power is 10–15mW, modulated mode, frequency is 10Hz). There are 7–10 daily procedures per course.

Soft Tissue Bruises, Sprains, Ligament Tears, Condition after Reduction of Dislocation

The technique is stable, contact with the ML-904-80 matrix pulsed IR laser head and the MM-50 magnet nozzle (wavelength is 904nm, maximum power is 60–80W, frequency is 80–150Hz), on 1–4 zones depending on the damaged area length, for two minutes on a zone. There are 8–10 daily procedures per course. If necessary, the course is repeated in two weeks (7–8 procedures every other day).

Furunculosis

Low level laser therapy is implemented in the stage of the infiltration increase to contribute to its resorption, regression; in the stage of dense infiltrate it contributes to rapid furuncle maturation, and after its opening – to regenerative processes.

Laser acupuncture (Table 4), successively on the points: GI4, E40, P5, RP10, V13, E25, TR6.

Technique 2. Local exposure is implemented directly on each furuncle for 1.5–2 minutes, at a distance of 1–1.5cm, in a stable manner with the KLO-635-15 laser head (wavelength is 635nm, maximum power is 10–15mW, modulated mode, frequency is 10Hz). The course of treatment consists of 8–10 daily procedures.

Technique 3. Paravertebrally. The technique is contact-mirror, stable with the LO-904-20 pulsed IR laser head and the ZN-35 mirror nozzle (wavelength is 904nm, power is 10–15W, frequency is 80–150Hz) on the zones, innervating dermatomes, on which lesion foci are located. There are 10–15 procedures per course.

Osteomyelitis

ILBI in the treatment of patients with fistulous forms of chronic osteomyelitis allows a 1.5 time reduction of the preoperative period while the number of recurrences is two times less, contributes to the faster reduction of endogenous intoxication and to the earlier normalization of the immunological reactivity of the organism, which is reflected in the rapid improvement of patients' health, the normalization of the biochemical indicators and blood rheology improving [Kalimbetov U.Zh., 1992].

ILBI technique (Table 5 or 6), there are 5–7 daily procedures per course.

Erosions, Ulcerations of the Mucous Membrane

Cytological examinations must exclude malignancy.

LLLT technique is stable, distant with the ML-904-80 matrix pulsed IR laser head and the MM-50 magnet nozzle (wavelength is 904nm, maximum power is 60–80W, frequency is 80–150Hz), on the zones of general exposure (Fig. 57, zones 1, 2), for two minutes on one zone. The illumination of the lesion is implemented with the same parameters for 2–5 minutes. The course consists of 5–7 daily procedures.

ILBI technique (Table 5 or 6), there are 5–7 daily procedures per course.

Endocrinology

Autoimmune Thyroiditis

Under the effect of ILBI the number of lymphocytes is increased, the number of T-helpers is reduced, the production of IgM is strengthened [Cheban A.K. et al., 1989].

ILBI technique (Table 5 or 6), there are 5–7 daily procedures per course.

Hypothyroidism

ILBI has a universal adaptogenic effect, the intake of hormonal drugs and the treatment time are reduced [Buylin V.A., Moskvina S.V., 2005].

ILBI technique (Table 5 or 6), there are 5–7 daily procedures per course.

The course of the external low level laser therapy is implemented additionally. LLLT technique is stable, contact with the ML-904-80 matrix pulsed IR laser head and the MM-50 magnet nozzle (wavelength is 904nm, maximum power is 60–80W, frequency is 80–150Hz), for one minute successively on each area on the following regions: the area of major neuro-vascular bundles on both sides of the neck, the anterior temporal and orbital regions, the 7th cervical vertebra (C7) and the projection of the thymus and thyroid.

Diabetes

ILBI in the complex treatment of patients with diabetes mellitus (DM) has a hypoglycemic, hypolipidemic, immunocorrecting effect, stimulates the residual insulin secretory function of the pancreas, increases the ability of tissues to utilize glucose. As a result, a more pronounced clinical and biochemical compensation is achieved in 82% of patients with insulin-dependent diabetes mellitus, and in 83% of patients with insulin-independent form of diabetes. There is a reduction of up to two times for the daily need for insulin and hypoglycemic drugs in comparison with conventional therapy [Lebedkov Ye.V., 1996; Onuchin S.G., 1995].

ILBI technique (Table 5 or 6), there are 5–7 daily procedures per course.

The course of the external low level laser therapy is implemented additionally. LLLT technique is stable, contact with the ML-904-80 matrix pulsed IR laser head and the MM-50 magnet nozzle (wavelength is 904nm, maximum power is 60–80W, frequency is 80–150Hz) on the zones: the calf of the lower leg – for five minutes, on the projection of the liver, pancreas and spleen – for two minutes [Kovaleva T.V., Moskvina S.V., 2003].

REFERENCES

1. *Amirkhanyan A.N., Moskvina S.V.* Laser therapy in dentistry. M.–Tver: Triada, 2008. 72. [in Russian]
2. *Andryukhin M.I., Avdoshin V.P., Mikhailova E.V.* Correction of drug clearance by kidneys assisted by laser therapy. *Collection of abstracts of the II Conf. in the Moscow region "Lasers in Medical Practice"*. Vidnoe, 1992: 25. [in Russian]
3. *Artykov Sh.N.* Clinical-experimental justification on the use of low-intensity laser radiation in complex surgical treatment of patients with liver cirrhosis: Abstract of the thesis. Candidate of medical sciences. M., 1992. 19. [in Russian]
4. *Avdoshin V.P.* Non-specific inflammatory diseases of the kidneys, urinary tract and reproductive organs in men. *Low level laser therapy*. M.: Tekhnika, 2000: 406–422. [in Russian]
5. *Babina E.M.* Clinical efficiency of intravenous laser blood irradiation in chronic bronchitis and its impact on the regulation of lipid peroxidation: Abstract of the thesis. Candidate of medical sciences: Abstract of the thesis. Candidate of medical sciences. Ryazan, 1995. 21. [in Russian]
6. *Babushkina G.V., Kartelishvili A.V.* A stage combined laser therapy in different clinical cases of ischemic heart disease. M.: Tekhnika, 2003. 106. [in Russian]
7. *Bakhmetev A.A.* The effectiveness of low-intensity laser radiation in the treatment of localized scleroderma. *Laser medicine*. 2002; 6 (4): 13. [in Russian]
8. *Barbarash O.L.* Stress reactivity and other non-specific defense mechanisms in patients with IHD: Abstract of the thesis. Doctor of medical sciences. M., 1996. 35. [in Russian]
9. *Baybekov I.M., Mavlyan-Khodzhayev R.Sh., Erstekis A.G., Moskvina S.V.* Erythrocytes under normal, pathological conditions and laser irradiation. Tver: Triada, 2008. 256. [in Russian]
10. *Bednarskiy A.S.* The use of endovascular laser therapy in treatment of EPH-gestosis: Abstract of the thesis. Candidate of medical sciences. SPb., 1996. 19. [in Russian]
11. *Borisova A.V.* Efficiency of intravenous laser therapy in patients with ischemic heart disease with stable angina: Abstract of the thesis. Candidate of medical sciences. M., 1997. 24. [in Russian]
12. *Brekhov E.I., Buylin V.A., Moskvina S.V.* Theory and practice of EHF-laser therapy. Tver: Triada, 2007. 112. [in Russian]
13. *Britova A.A.* Laser reflexology in the prevention and treatment of periodontal diseases: Abstract of the thesis. Doctor of medical sciences. SPb., 1992. 34. [in Russian]
14. *Busalayeva E.I.* Use of vibro-thermal testing and magneto-infrared laser therapy in the diagnosis and treatment of diabetic distal polyneuropathy: Abstract of the thesis. Candidate of medical sciences. Kazan, 1999. 23. [in Russian]
15. *Buylin V.A.* Semiconductor lasers in treatment of postoperative intestinal paresis: Abstract of the thesis. Candidate of medical sciences. M., 1990. 21. [in Russian]
16. *Buylin V.A., Moskvina S.V.* Low-intensity lasers in the treatment of various diseases. M.: Firma "Tekhnika", 2001. 176. [in Russian]
17. *Buylin V.A., Moskvina S.V.* Low-intensity lasers in the treatment of various diseases. M.: Tekhnika, 2005. 174. [in Russian]
18. *Cheban A.K., Golovach R.E., Chumak A.A. et al.* Low-energy laser blood irradiation in thyroid pathology. *Abstracts of All-Union. Conf. "Effect of low energy laser irradiation on blood"*. Kiev, 1989: 167–168. [in Russian]
19. *Danilevskiy N.F., Mokhort V.V., Ruban S.A., Danchenko A.N.* The therapeutic effectiveness of intravascular laser blood irradiation in the treatment of severe ulcerous-necrotic stomatitis. *Abstracts of All-Union. Conf. "Effect of low energy laser irradiation on blood"*. Kiev, 1989 (1): 79–80. [in Russian]
20. *Danilevskiy N.F., Mokhort V.V., Ruban S.A., Danchenko A.N.* The use of intravascular laser blood irradiation in complex treatment of severe generalized periodontitis. *Abstracts of All-Union. Conf. "Effect of low energy laser irradiation on blood"*. Kiev, 1989: 78–79. [in Russian]
21. *Davydova Yu.G.* Structural and metabolic status of erythrocytes in patients with acute salpingo-ophoritis in laser therapy dynamics: Abstract of the thesis. Candidate of medical sciences. Tomsk, 1996. 26. [in Russian]

22. *Deyneka E.D.* The effectiveness of the use of endovascular laser blood irradiation in complex treatment of hemophthalmus of various etiology: Abstract of the thesis. Candidate of medical sciences. Voronezh, 1996. 22. [in Russian]
23. *Dochiya A.A., Kartelishv A.V.* Combined laser therapy for muscle-compression (tunnel) syndrome. M.: Tekhnika, 2002. 48. [in Russian]
24. *Egorov V.E., Moskvina S.V., Titov M.N. et al.* Laser therapy in complex treatment of patients with erysipelas. *Proceedings of the 1st Int. Congress "Laser and Health"*. M.–Limassol: Tekhnika, 1997: 69. [in Russian]
25. *Erzhanov O.N.* Comparative evaluation of the effectiveness of intravascular laser and ultraviolet blood irradiation in the treatment of surgical infections: Abstract of the thesis. Candidate of medical sciences. Almaty, 1993. 23. [in Russian]
26. *Evgrafov V.Yu.* On the application of laser blood irradiation in patients with proliferative diabetic retinopathy. 2006. <http://e-oculist.narod.ru/Section3/010.htm> [in Russian]
27. *Fedorova T.A., Moskvina S.V., Apolikhina I.A.* Laser therapy in obstetrics and gynecology. M.–Tver: Triada, 2009. 352. [in Russian]
28. *Geynits A.V., Moskvina S.V.* Laser therapy in cosmetology and dermatology. M.–Tver: Triada, 2010. 400. [in Russian]
29. *Geynits A.V., Moskvina S.V.* New technologies of intravenous laser blood irradiation: "ILBI + UVBI" and "ILBI-405". Tver: Triada, 2009. 40. [in Russian]
30. *Geynits A.V., Moskvina S.V., Achilov A.A.* Intravenous laser blood irradiation. M.–Tver: Triada, 2008. 144. [in Russian]
31. *Geynits A.V., Moskvina S.V., Achilov A.A.* Intravenous laser blood irradiation. M.–Tver: Triada, 2012. 336. [in Russian]
32. *Gimaeva L.A.* The use of helium-neon laser in the treatment of apical periodontitis: Abstract of the thesis. Candidate of medical sciences. M., 1990. 13. [in Russian]
33. *Grishanova Yu.D.* Intravenous laser therapy of patients with persistent lumbar radicular syndrome after discectomy: Abstract of the thesis. Candidate of medical sciences. N. Novgorod, 1995. 22. [in Russian]
34. *Isakov S.A.* Intravascular laser irradiation in the treatment of patients with eczema and atopic dermatitis: Abstract of the thesis. Candidate of medical sciences. M., 1994. 16. [in Russian]
35. *Islamkulova L.B.* The phospholipid composition of organs and lymphocytes in infectious-allergic myocarditis and its changes in the treatment by various methods: Abstract of the thesis. Candidate of medical sciences. Almaty, 1992. 22. [in Russian]
36. *Ivanchenko L.P., Kozdoba A.S., Moskvina S.V.* Laser therapy in urology. M.–Tver: Triada, 2009. 132. [in Russian]
37. *Ivanchenko L.P., Mufaged M.L., Moskvina S.V.* Local administration of Interferon-alpha-2b in combination with magnetic-exposure in the conservative treatment of fibroplastic induration of the penis (Peyronie's disease). *Proceedings of the anniversary XX Int. Scient. Conf. "The use of lasers in medicine and biology"*. Yalta, 2003: 26–29. [in Russian]
38. *Ivanyuta L.I., Belis N.I., Ivanyuta S.O. et al.* Intravascular laser irradiation of blood in the treatment of female infertility. *Materials of Int. Conf. "Laser and information technologies in medicine of the XXI century"*. SPb., 2001: 166–167. [in Russian]
39. *Kalimbetov U.Zh.* On the treatment of chronic hematogenous osteomyelitis of long pipe bones using laser irradiation: Abstract of the thesis. Candidate of medical sciences. Almaty, 1992. 21. [in Russian]
40. *Kapustina G.M., Moskvina S.V., Titov M.N.* Intravenous laser blood irradiation (ILBI). *Medical Marketing & Media*. 1996; 24: 20–21. [in Russian]
41. *Kartelishv A.V., Rumyantsev A.G., Moskvina S.V. et al.* Clinical-experimental analysis of the efficiency of fetus and newborn pharmaco-laser improvement during pregnancy with placental insufficiency. *Laser medicine*. 2004; 8 (1–2): 64–67. [in Russian]
42. *Kartelishv A.V., Vernekina N.S.* Combined low-intensity laser therapy in psychiatric practice. M.: Firma "Tekhnika", 2000. 44. [in Russian]

43. *Khalyastova E.A., Moskvina S.V.* The use of magnetic-laser therapy in the treatment of chronic inflammatory disease of female reproductive organs. *Proceedings of the XVIII Int. Scient. Conf. "The use of lasers in medicine and biology"*. Yalta, 2002: 45. [in Russian]
44. *Khazov S.V., Kumeyko O.V., Krasnoshchekov A.A.* Laser therapy in patients with acute ischemic stroke. *Proceedings of the I Volga Region scientific-practical. Conf. "Lasers in medicine and ecology"*. Samara-M.: Firma "Tekhnika", 1998: 81–82. [in Russian]
45. *Khodos Kh.-B.G.* Nervous Diseases. M.: Medical Information Agency, 2002. 512. [in Russian]
46. *Kiani Ali, Moskvina S.V., Ivanov O.L., Grabovskaya O.V.* Low-intensity laser irradiation in the treatment of patients with nodular angiitis. *Laser medicine*. 2005; 9 (4): 9–14. [in Russian]
47. *Klimova L.V.* Intravenous laser blood irradiation in complex intensive therapy of severe traumatic brain injury: Abstract of the thesis. Candidate of medical sciences. Rostov-on-Don, 1998. 23. [in Russian]
48. *Klyushnikova O.N.* Comparative efficiency of treating chronic periodontitis in the restoration of the supporting function of the teeth: Abstract of the thesis. Candidate of medical sciences. M., 1992. 22. [in Russian]
49. *Kochetkov A.V., Moskvina S.V.* Laser therapy of patients with cerebral stroke. Tver: Triada, 2004. 51. [in Russian]
50. *Kochetkov A.V., Moskvina S.V., Karneev A.N.* Laser therapy in neurology. M.–Tver: Triada, 2012. 360. [in Russian]
51. *Kochetkov A.V., Moskvina S.V., Kosmylin A.G.* Over-arterial matrix laser therapy of patients with dyscirculatory encephalopathy. *Laser medicine*. 2005; 9 (1): 9–12. [in Russian]
52. *Kochetkov M.A.* The use of low-intensity laser irradiation in the treatment of patients with granuloma annulare: Abstract of the thesis. Candidate of medical sciences. M., 2000. 18. [in Russian]
53. *Konovalov Ye.P., Kavkalo D.N., Volynets L.N., Kavkalo G.D.* Effect of intravascular laser blood irradiation (ILBI) on the functional activity of a number of physiological systems in patients with septic complications. *Abstracts of All-Union. Conf. "Effect of low energy laser irradiation on blood"*. Kiev, 1989: 102–103. [in Russian]
54. *Koshelev V.N., Semina E.A., Kamalyan A.B.* Comparative evaluation of the efficacy of percutaneous and intravascular laser blood irradiation. *Materials of Int. Conf. "The clinical and experimental use of new laser technologies"*. M.–Kazan, 1995: 395–397. [in Russian]
55. *Kovaleva T.V., Moskvina S.V.* Experience of combined outpatient laser therapy in diabetic patients with dyslipidemia. *Proceedings of the anniversary XX Int. Scient. Conf. "The use of lasers in medicine and biology"*. Yalta, 2003: 37–40. [in Russian]
56. *Krechina E.K., Maslova V.V., Shidova A.V., Moskvina S.V.* Comparative evaluation of the impact of low-intensity pulsed and continuous laser irradiation of red and infrared spectra on microcirculation in the complex treatment of chronic periodontitis. *Laser medicine*. 2009; 13 (2): 22–26. [in Russian]
57. *Kubasova E.S.* Laser puncture of myofascial pain syndrome. *Lasers and life*. 1999; 19 (71): 12. [in Russian]
58. Laser therapy in medical rehabilitation and prevention programs: clinical guidelines // Gerasimenko M.Yu., Geynits A.V., Moskvina S.V. et al. M., 2015. 80. [in Russian]
59. *Lebedkov Ye.V.* Clinical and biochemical justification for the use of laser blood irradiation in the treatment of diabetes complicated by purulent necrotic infection: Abstract of the thesis. Candidate of medical sciences. M., 1996. 26. [in Russian]
60. *Ledin A.O.* Intravenous laser blood irradiation in complex surgical treatment of patients with non-specific purulent-destructive lung diseases: Abstract of the thesis. Candidate of medical sciences. M., 1994. 24. [in Russian]
61. *Lepilin A.V.* Prevention and pathogenetic treatment of pyo-infectious complications of traumatic injuries of facial bones: Abstract of the thesis. Doctor of medical sciences. M., 1995. 43. [in Russian]
62. *Leyderman N.E., Kochetkov A.V., Moskvina S.V.* LASMIK® technology in complex rehabilitation treatment of patients with chronic cerebral ischemia. *Bulletin of new medical technologies*. 2009; 4: 104–106. [in Russian]

63. Liev A.A., Apakidze T.V., Kovalenko V.V. et al. Laser therapy of myofascial lumbar ischialgia syndromes. Kislovodsk, 1996. 19. [in Russian]
64. Low-intensity laser physiotherapy in the complex method of treating chronic headache syndrome: Methodological guidelines / Compiled by Skobelkin O.K., Yusupov T.Yu., Saykovskiy R.S. M., 1997. 12. [in Russian]
65. Lutoshkin M.B. Low-intensity laser irradiation in nephrology. M.: Tekhnika, 2003. 73. [in Russian]
66. Makashova V.V. The use of LILI in treatment of patients with viral hepatitis. M.: Tekhnika, 2003. 25. [in Russian]
67. Makhmutova T.I. Evaluation of immune and biochemical factors in the pathogenesis of retinal vein thrombosis and effectiveness of endovascular therapy: Abstract of the thesis. Candidate of medical sciences. M., 1995. 23. [in Russian]
68. Malinovskaya P.E., Sirenko Yu.N., Krasnitskiy S.S. et al. Instrumental and laboratory methods to assess the effectiveness of quantum hemotherapy in patients with acute coronary insufficiency. *Abstracts of All-Union. Conf. "Effect of low energy laser irradiation on blood"*. Kiev, 1989: 124–125. [in Russian]
69. Malyev B.M., Shesterina M.B. Lasers in phthisiopulmonology / Ed. S.V. Moskvin. M.: "Tekhnika", 2001. 302. [in Russian]
70. Mallak I.K. Status of lipid transport system and lipid peroxidation in patients with internal and retrocervical endometriosis: Abstract of the thesis. Candidate of medical sciences. Minsk, 1995. 17. [in Russian]
71. Martsiyash A.A. Stress modulating effects of invasive helium-neon laser therapy in patients with ischemic heart disease: Abstract of the thesis. Candidate of medical sciences. M., 1996. 25. [in Russian]
72. Mikhaylova E.V. Effect of intravenous laser irradiation on blood rheological properties during purulent meningitis and meningoencephalitis in children. *Epidemiology and infectious diseases*. 2000; 2: 38–40. [in Russian]
73. Moskvin S. Low-level laser therapy (LLLT) in Russia: history of study of biomodulation action (BMA) mechanisms of low-intensity laser irradiation (LILI) and its therapeutic application practice. *SPIE Photonics West 2016 BIOS. Conference 9695: Mechanisms of Photobiomodulation Therapy XI*. 2016: 137.
74. Moskvin S.V. Basics of laser therapy. Series "Effective laser therapy". Vol. 1. M.–Tver: Triada, 2016. 896. [in Russian]
75. Moskvin S.V. Laser therapy and biological rhythms. *Collection of scientific papers "Modern laser medicine. Theory and practice"*. M., 2007; 1: 26–31. [in Russian]
76. Moskvin S.V. Laser therapy as a modern stage of heliotherapy (the historical aspect). *Laser medicine*. 1997; 1 (1): 44–49. [in Russian]
77. Moskvin S.V. Laser therapy in dermatology: vitiligo. M.: Tekhnika, 2003. 125. [in Russian]
78. Moskvin S.V. Low-Level Laser Therapy in Russia: History, Science and Practice. *J. Lasers. Med. Sci.* 2017 Spring; 8 (2): 56–65. doi: 10.15171/jlms.2017.11.
79. Moskvin S.V. On the problem of the mechanisms of the therapeutic effect of the low-intensity laser irradiation (LILI). *Bulletin of new medical technologies*. 2008; 15 (1): 167–172. [in Russian]
80. Moskvin S.V. Principles of construction and hardware implementation of optoelectronic devices based on pulsed semiconductor lasers for biomedical applications: Abstract of the thesis. Candidate of engineering sciences. M., 2003. 19. [in Russian]
81. Moskvin S.V. Systemic analysis of efficiency of biological systems management by low-energy laser irradiation: Abstract of the thesis. Doctor of biological sciences. Tula, 2008. 38. [in Russian]
82. Moskvin S.V. The effectiveness of laser therapy. M.: Tekhnika, 2003. 256. [in Russian]
83. Moskvin S.V. The effectiveness of laser therapy. Series "Effective laser therapy". Vol. 2. M.–Tver: Triada, 2014. 896. [in Russian]
84. Moskvin S.V. Thermodynamic model of mechanisms of therapeutic action of low-intensity laser irradiation (LILI). *Laser medicine*. 2010; 14 (1): 48–51. [in Russian]
85. Moskvin S.V., Achilov A.A. Basics of laser therapy. M.–Tver: Triada, 2008. 256. [in Russian]

86. Moskvina S.V., Achilov A.A. Laser therapy by "Matrix" devices. M.–Tver: Triada, 2008. 144. [in Russian]
87. Moskvina S.V., Buylin V.A. Low-intensity laser therapy. M.: TOO "Firma "Tekhnika", 2000. 726. [in Russian]
88. Moskvina S.V., Buylin V.A. Optimization of laser exposure. *Low-intensity laser therapy*. M.: TOO "Firma "Tekhnika", 2000: 141–209. [in Russian]
89. Moskvina S.V., Geynits A.V., Khazov M.B., Fedorishchev I.A. Laser phoresis of hyaluronic acid and laser anti-cellulite programs in cosmetology (LASMIK® technology). M.–Tver: Triada, 2010. 96. [in Russian]
90. Moskvina S.V., Geynits A.V., Kochetkov A.V. et al. Laser-vacuum massage LASMIK® in medicine and cosmetology. M.–Tver: Triada, 2014. 160. [in Russian]
91. Moskvina S.V., Gorbani N.A. Laser-vacuum massage. M.–Tver: Triada, 2006. 72. [in Russian]
92. Moskvina S.V., Khadartsev A.A. EHF-laser therapy. M.–Tver: Triada, 2016. 168. [in Russian]
93. Moskvina S.V., Konchugova T.V. Justification for application of laser phoresis of biologically active substances. *Problems of balneology, physiotherapy and exercise therapy*. 2012; 5: 57–63. [in Russian]
94. Moskvina S.V., Kupeev V.G. Laser chromo- and color therapy. M.–Tver: Triada, 2007. 95. [in Russian]
95. Moskvina S.V., Mufaged M.L., Buylin V.A. et al. Laser therapy of urogenital diseases. Tver: Triada, 2004. 160. [in Russian]
96. Moskvina S.V., Nasedkin A.N., Kochetkov A.V. et al. Therapy by matrix pulsed lasers of red spectrum. Tver: Triada, 2007. 112. [in Russian]
97. Moskvina S.V., Nasedkin A.N., Osin A.Ya., Khan M.A. Laser therapy in pediatrics. M.–Tver: Triada, 2009. 480. [in Russian]
98. Moskvina S.V., Nasedkin A.N., Osin A.Ya., Khan M.A. Laser therapy in pediatrics. M.: EKSMO, 2010. 479. [in Russian]
99. Moskvina S.V., Ponomarenko G.N. Laser therapy by devices of "Matrix" and "LASMIK" series. M.–Tver: Triada, 2015. 208. [in Russian]
100. Moskvina S.V., Zakharov P.I. Laser therapy and prevention of duodenal ulcer. *Russian journal of physiotherapy, balneology and rehabilitation*. 2013; 4: 23–26. [in Russian]
101. Mufaged M.L., Ivanchenko L.P., Moskvina S.V. et al. Laser therapy in urology. Tver: Triada, 2007. 132. [in Russian]
102. Nasedkin A.A., Moskvina S.V. Laser therapy of patients with heroin addiction. Tver: Triada, 2004. 48. [in Russian]
103. Nasedkin A.N., Moskvina S.V. Laser therapy in otorhinolaryngology. M.–Tver: Triada, 2011. 208. [in Russian]
104. Onuchin S.G. On the justification of the clinical efficacy of low-intensity helium-neon (He-Ne) laser irradiation in the treatment of patients with diabetes: Abstract of the thesis. Candidate of medical sciences. N. Novgorod, 1995. 20. [in Russian]
105. Patent 2149655 RU, Int.Cl. A61N5/06, A61H39/06. Method for treating epilepsy / V.I. Gernets, S.V. Moskvina. – № 97116791/14. Date of filing: 16.10.97. Publ. 27.08.2000. Bull. № 15. Priority 16.10.97. [in Russian]
106. Patent 2456035 RU, Int.Cl. A61N5/067, A61K31/728, A61P43/00. Method for laser phoresis of biologically active substances / S.V. Moskvina. – № 2010145006/14(064880). Date of filing: 03.11.2010. Publ. 20.07.2012. [in Russian]
107. Patent 2513474 RU, Int.Cl. A61N5/067. Method of treating reactivated form of urogenital cytomegalovirus infection in females of reproductive age / S.V. Moskvina, Yu.N. Perlamutrov, N.I. Chernova, K.B. Olkhovskaya. – № 2013115641/13. Date of filing: 08.04.2013. Publ. 17.02.2014. [in Russian]
108. Patent 2539535 RU, Int.Cl. A61N5/067. Matrix laser emitter for physiotherapeutic device / S.V. Moskvina. – № 2013137646/14. Date of filing: 12.08.2013. Publ. 20.01.2015. Bull. № 2. [in Russian]

109. Patent 2562316 RU, Int.Cl. A61N5/067. Method of laser therapy of patients with psoriasis / S.V. Moskvina, S.R. Utts, D.A. Shnajder. – № 2014149852/14. Date of filing: 10.12.2014. Publ. 10.09.2015. Bull. № 25. [in Russian]
110. Patent 2562317 RU, Int.Cl. A61N5/067. Method for laser therapy of patients with atopic dermatitis / S.V. Moskvina, S.R. Utts, D.A. Shnajder, O.P. Gus'kova. – № 2014151174/14. Date of filing: 17.12.2014. Publ. 10.09.2015. Bull. № 25. [in Russian]
111. *Perstnev S.V.* The use of laser blood irradiation in the treatment of drug-resistant affective states of patients with endogenous psychoses: Abstract of the thesis. Candidate of medical sciences. SPb., 1995. 16. [in Russian]
112. *Petushinova V.M.* The use of low-energy laser irradiation in complex treatment of patients with chronic inflammatory colonic diseases of the: Abstract of the thesis. Candidate of medical sciences. M., 1993. 24. [in Russian]
113. *Plotnikov A.V.* Intravenous laser therapy of patients with eczema: Abstract of the thesis. Candidate of medical sciences. M., 1991. 15. [in Russian]
114. *Podelinskaya L.V.* Laser therapy in complex treatment and systemic localized scleroderma in children: Abstract of the thesis. Candidate of medical sciences. M., 1996. 26. [in Russian]
115. *Reshetnikova N.L., Stegunina L.I.* Effect of intravenous laser blood irradiation on auditory function in Meniere's disease. *Proceedings of the I Volga region scientific-practical. Conf. "Lasers in medicine and ecology"*. Samara–M.: Firma "Tekhnika", 1998: 71–72. [in Russian]
116. *Revutskiy E.L., Karpenko V.V., Mel'nik P.I., Rozhnev A.N.* Effect of intravenous low-energy laser blood irradiation (ILBI) on hemorheological blood properties in patients with ischemic heart disease and hypertension. *Abstracts of All-Union. Conf. "Effect of low energy laser irradiation on blood"*. Kiev, 1989: 149–150. [in Russian]
117. *Rogacheva G.I., Nasedkin A.N., Marushkin D.V., Moskvina S.V.* Combined laser therapy in children with chronic hearing loss. M.: Tekhnika, 2002. 31. [in Russian]
118. *Salova L.M.* Laser therapy of biliary dyskinesia: Abstract of the thesis. Candidate of medical sciences. M., 1991. 24. [in Russian]
119. *Semenova T.B.* Laser therapy in complex treatment of herpes. *Laser medicine*. – 1997; 1 (1): 38–39. [in Russian]
120. *Sernyak P.S., Zakharov V.V., Denisov V.K. et al.* The use of endovascular laser blood irradiation in patients with sepsis undergoing program hemodialysis and after donor kidney allografting. *Proceedings of Int. Conf. "The clinical and experimental use of new laser technologies"*. Kazan, 1995: 408–410. [in Russian]
121. *Shulga V.A.* Intravenous use of helium-neon laser in the treatment of dermatoses. *Proceedings of Int. Conf. "The clinical and experimental use of new laser technologies"*. M.–Kazan, 1995: 421. [in Russian]
122. *Skupchenko V.V., Makhovskaya T.G.* Laser therapy in neurology. Samara–Khabarovsk, 1993. 81. [in Russian]
123. *Skupchenko V.V., Makhovskaya T.G., Mironova L.P.* Prospects for the use of low-energy laser exposure on blood in young patients with cerebrovascular diseases. *Abstracts of All-Union. Conf. "Effect of low energy laser irradiation on blood"*. Kiev, 1989: 155–157. [in Russian]
124. *Smirnova M.S.* Laser and exercise therapy for optimizing the complex treatment of acute pneumonia and chronic bronchitis: Abstract of the thesis. Candidate of medical sciences. N. Novgorod, 1996. 18. [in Russian]
125. *Sosnovskiy I.B.* Pathogenetic justification and forecasting of associated laser therapy of erectile dysfunction in patients with chronic prostatitis: Thesis. Doctor of medical sciences. Pyatigorsk, 2012. 282. [in Russian]
126. *Stupak V.V.* Low-intensity laser irradiation in the treatment of patients with spinal trauma. *Proceedings of the II Intern. Congress "Laser and Health"*. M., 1999: 113–114. [in Russian]
127. *Temirbulatov V.I.* Ways to improve the effectiveness of treatment of lung abscess: Abstract of the thesis. Candidate of medical sciences. Voronezh, 1994. 25. [in Russian]
128. *Toygabayev A.A., Lapin V.I., Amralin E.Zh. et al.* The use of low-energy laser in patients with urgent conditions. *Abstracts of All-Union. Conf. "Effect of low energy laser irradiation on blood"*. Kiev, 1989: 163–165. [in Russian]

129. *Varivoda E.S.* Therapeutic and diagnostic laparoscopy in patients with chronic hepatitis and liver cirrhosis: Abstract of the thesis. Candidate of medical sciences. L'vov, 1990. 16. [in Russian]
130. *Vasilyeva O.A.* Clinical effectiveness of low-intensity laser exposure in pregnant women with placental insufficiency on the fetus and newborn: Abstract of the thesis. Candidate of medical sciences. M., 1998. 25. [in Russian]
131. *Vasilyeva O.A.* Stage pharmaco-laser therapy and prevention in the complex system of the fetus and newborn health improvement with placental insufficiency: Abstract of the thesis. Doctor of medical sciences. M., 2005. 48. [in Russian]
132. *Vilshonkov A.I.* Complex methods of treating patients with psoriasis arthropica (clinico-experimental research): Abstract of the thesis. Candidate of medical sciences. M., 1996. 22. [in Russian]
133. *Volkov V.M.* The effectiveness of the integrated application of selective phototherapy and laser puncture in patients with psoriasis with the use of modern domestic units: Abstract of the thesis. Candidate of medical sciences. M., 1990. 13. [in Russian]
134. *Vorozhtcov A.A., Moskvina S.V., Zenger V.G., Nasedkin A.N.* Laser technologies in treatment of patients with chronic rhinosinusitis polyposa. Tver: Triada, 2005. 47. [in Russian]
135. *Votyakov V.I., Sokolovskaya A.D., Andreeva O.D. et al.* On the optimization of the associated effects of laser irradiation and chemotherapeutic agent on the course of experimental herpes infection. *Optimization of exposure in physiotherapy* / Ed. Ulashchik V.S. and Kobrik V.A. Minsk, Belarus, 1980: 79–87. [in Russian]
136. *Yerofeyev A.V., Zaichikov V.M., Kataev M.I. et al.* Experience of the application of intravenous low-intensity laser irradiation in acute myocardial infarction. *Abstracts. Conf. "The use of lasers in medicine"*. M., 1985: 7–8. [in Russian]
137. *Yu H.S., Chang K.L., Yu C.L. et al.* Helium-neon laser irradiation stimulates migration and proliferation in melanocytes and induces repigmentation in segmental-type vitiligo. *The Journal of Investigative Dermatology*. 2003; 120 (1): 56–64.
138. *Yurkevich O.I.* Endogenous intoxication in gestosis and differentiated methods of efferent therapy: Abstract of the thesis. Candidate of medical sciences. SPb., 1996. 24. [in Russian]
139. *Zakharov P.I., Moskvina S.V.* Comparative experimental-clinical study of the effectiveness of the single-frequency and BIO-mode laser exposure on duodenal ulcer. *Collection of scientific papers "Modern laser medicine. Theory and practice"*. M., 2007; 1: 116–122. [in Russian]
140. *Zakharov P.I., Moskvina S.V., Paliy V.I.* Prevention of duodenal ulcer recurrence using low-level laser therapy. *Laser medicine*. 2005; 9 (1): 47–49. [in Russian]
141. *Zakharov V.V., Berko I.M., Levin V.F. et al.* The effectiveness of treating patients with erosive and ulcerative disorders of the upper gastrointestinal tract using low-energy laser irradiation in patients on hemodialysis. *Proceedings of Int. Conf. "The clinical and experimental use of new laser technologies"*. Kazan, 1995: 50–52. [in Russian]
142. *Zakharov Ya.Yu.* Magneto-infrared-laser therapy in regenerative treatment of patients with autonomic-sensory post-radiation polyneuropathy: Abstract of the thesis. Candidate of medical sciences. M., 2002. 19. [in Russian]
143. *Zakharova M.P.* Application vibro-magnito-thermotherapy and laser irradiation in complex treatment of patients with chronic abacterial prostatitis with chronic pelvic pain syndrome: Abstract of the thesis. Candidate of medical sciences. Tomsk, 2014. 23. [in Russian]
144. *Zarembo I.A.* Effect of intravascular blood irradiation by helium-neon laser on the composition of peripheral blood and protein spectrum in patients with bronchiectasis. *Abstracts of All-Union. Conf. "Influence of low energy laser irradiation on blood"*. Kiev, 1989: 89–91. [in Russian]
145. *Zazulevskaya L.Y., Apsatarov E.A., Mosesyants E.N. et al.* The rheological parameters of blood in patients with severe intoxication during endovascular blood irradiation. *Abstracts of All-Union. Conf. "Influence of low energy laser irradiation on blood"*. Kiev, 1989: 88–89. [in Russian]
146. *Zhukov B.N., Lysov N.A., Moskvina S.V. et al.* Experimental justification of laser irradiation in autografting. *Laser medicine*. 2003; 7 (3–4): 45–54. [in Russian]
147. *Zinkovskaya T.M.* Clinical and pathological evaluation of infrared and helium-neon laser therapy in patients with cardiac angina: Abstract of the thesis. Candidate of medical sciences. M., 1995. 29. [in Russian]

TABLE OF CONTENTS

ABBREVIATIONS	3
INTRODUCTION.....	4
GENERAL POINTS OF LOW LEVEL LASER THERAPY	6
Mechanisms of the Therapeutic Effect of Low Level Laser Therapy	6
Equipment for Low Level Laser Therapy	8
The Peculiarities of Applying Various Low Level Laser Therapy Techniques.....	10
Low Level Laser Therapy Protocols.....	12
SPECIAL TECHNIQUES OF LOW LEVEL LASER THERAPY.....	25
Obstetrics and Gynecology	25
Acute Bartholinitis (in the Infiltration Phase), Subacute and Chronic	25
Purulent-Septic Complications.....	25
Coleitis, Cervicitis (Endocervicitis).....	25
Kraurosis Vulvae, Idiopathic Neurogenic Vulva Itching	29
True Erosions and Cervical Pseudo Erosions	30
Some Types of Infertility, Ovarian Hypofunction, Some Forms of Diencephalic Pathology and Hypothalamo-Pituitary Disorders....	30
Nonspecific Salpingitis and Salpingoophoritis (Subacute and Chronic).....	32
Menstrual Disorder, Ovarian Dysfunction and Algodismenorrhea....	33
Puerperal Endometritis	34
Cracked Nipples, Lactostasis, Puerperant Hypogalactia.....	34
Late Toxemia of Pregnancy (EPH-Gestosis).....	35
Prevention of Postoperative Complications.....	35
Fetoplacental Insufficiency	35
Endometriosis	36
Dermatology.....	36
Acne.....	36
Alopecia.....	37
Vitiligo.....	38

Recurrent Herpes Simplex	40
Pruritic Dermatitis (Atopic and Contact Dermatitis, Eczema, Lichen Planus, Localized Itching of the Skin).....	41
Skin Angiitis (Vasculitis)	42
Granuloma Annulare	42
Localized Scleroderma	42
Herpes Zoster	43
Pyoderma	43
Psoriasis	43
Erysipelas.....	47
Lyell's Syndrome.....	48
Eczema.....	48
Musculoskeletal Disorders	49
Osteoarthritis	50
Rheumatoid Arthritis	50
Fibromyalgia.....	50
Epicondylitis (Enthesopathy)	51
Tendovaginitis. Myositis	52
Heel Spurs	53
Peripheral Vascular Disorders.....	54
Atherosclerotic Arteriopathy of the Lower Extremities.....	54
Diabetic Angiopathy of Lower Extremities.....	54
Raynaud's Syndrome.....	54
Obliterating Vessel Lesions of the Extremities	55
Phlebitis, Thrombophlebitis, Postthrombophlebitic Trophic Disorders and Ulcers.....	57
Gastrointestinal Disorders	57
Viral Hepatitis	57
Gastritis, Duodenitis, Dyskinesia of the Digestive Organs	60
Obstructive Jaundice	61
Acute Intestinal Obstruction	61
Acute and Chronic Cholecystitis	61
Intoxication.....	61
Chronic Pancreatitis	62
Acute Pancreatitis.....	62
Hepatic Insufficiency.....	62

Chronic Hepatitis.....	63
Chronic Nonulcerative Colitis	63
Hepatic Cirrhosis.....	63
Gastroduodenal Ulcer.....	64
Cardiology.....	65
Hypertension.....	65
Myocardial Infarction (Acute Period)	69
Infectious-Allergic Myocarditis	70
Ischemic Heart Disease, Cardiac Angina	70
Acute Coronary Insufficiency	71
Paroxysmal Atrial Fibrillation.....	72
Heart Defects.....	73
Sinus Dysfunction Syndrome	73
Neurology	73
Vibration Disease	73
Hypothalamic Syndromes	73
Headaches.....	73
Degenerative-Dystrophic Spine Disorders.....	76
Discirculatory Encephalopathy	79
Ischemic and Traumatic Myelopathy.....	80
Myofascial Pain Syndrome	80
Trigeminal Neuralgia.....	85
Neurasthenia	85
Neuroinfections (Meningitis and Meningoencephalitis)	86
Facial Nerve Neuropathy (Neuritis)	87
Sciatic Nerve Neuropathy	88
Acute Cerebrovascular Disease	88
Polyneuropathy.....	89
Traumatic Brain Injury.....	90
Postoperative Complications.....	91
Radicular Syndrome after Discectomy.....	91
Multiple Sclerosis.....	91
Chronic Fatigue Syndrome	91
Cerebral Stroke.....	92
Epilepsy	92

Otorhinolaryngology	93
Adenoid Vegetations of II–III Degree	93
Eustachitis, Otitis External and Media. Cochleoneuritis.	
Meniere’s Disease	93
Sensorineural Hearing Loss	95
Acute Rhinitis.....	95
Rehabilitation after Rhinosurgery	95
Tonsillectomy	95
Chronic Vasomotor Rhinitis.....	96
Chronic Maxillary Sinusitis, Frontal Sinusitis	96
Chronic Tonsillitis	96
Chronic Pharyngitis. Nasopharyngitis	96
Ophthalmology	97
Diabetic Retinopathy.....	97
Vitreous Hemorrhage (Hemophthalmos).....	97
Retinal Vein Thrombosis.....	97
Psychiatry	98
Abstinence Syndrome of Patients with Alcoholism.....	98
Abstinence Syndrome of Patients with Drug Addictions	98
Schizophrenia	99
Endogenous Psychoses.....	99
Pulmonology	100
Lung Abscess.....	100
Bacterial Destruction of the Lungs.....	100
Bronchial Asthma. Allergic Processes in the Lungs	100
Bronchiectatic Disease	101
Acute Bronchitis and Chronic Bronchitis	
in the Exacerbation Phase.....	102
Acute Pneumonia. Exacerbation of Chronic Pneumonia.....	103
Pleuritis.....	103
Chronic Nonspecific Lung Diseases.....	103
Chronic Obstructive Bronchitis	104
Dentistry	104
Temporomandibular Arthritis	104
Aphthous and Herpetic Stomatitis.....	104

Periodontal Disease (Gingivitis, Parodontitis)	105
Purulent Infection Processes of Maxillofacial Area, Phlegmons.....	106
Benign Migratory Glossitis.....	106
Mandibular Fracture.....	107
Periodontitis.....	107
Periodontitis, Enamel Hyperesthesia, Postoperative and Traumatic Oral Tissue Injury	107
Replantation.....	108
Sialoadenitis.....	108
Melkersson-Rosenthal Syndrome	108
Urology	108
Amyloidosis.....	108
Infertility.....	108
Glomerulonephritis.....	109
Diabetic Nephropathy	109
Complications after Extracorporeal Lithotripsy	109
Low Level Laser Therapy during Hemodialysis and after Kidney Transplantation.....	110
Urolithiasis.....	111
Acute Pyelonephritis	112
Acute and Chronic Cystitis.....	113
Postoperative Sutures	114
Prostatitis	114
Traumatic Ureteral Fistulas.....	118
Urogenital Infections, Urethritis	118
Fibroplastic Induration of the Penis (Peyronie's Disease).....	119
Chronic Kidney Disease	119
Chronic Pyelonephritis.....	119
Surgery	120
Anesthesiology	121
Hemorrhoids.....	121
Pyoinflammatory Diseases.....	121
Purulo-Necrotic Complications of Diabetic Patients	122
Lymphadenitis	122
Burns and Frostbites	122
Bone Fractures.....	123

Peritonitis.....	123
Postoperative Complications.....	124
Wounds (Home, Sports, Gunshot).....	126
Rehabilitation after Chemical Peelings, Laser Resurfacing.....	127
Syndrome of Disseminated Intravascular Coagulation (DIC).....	128
Anal Fissure.....	128
Soft Tissue Bruises, Sprains, Ligament Tears, Condition after Reduction of Dislocation.....	128
Furunculosis.....	129
Osteomyelitis.....	129
Erosions, Ulcerations of the Mucous Membrane.....	129
Endocrinology.....	130
Autoimmune Thyroiditis.....	130
Hypothyroidism.....	130
Diabetes.....	130
REFERENCES.....	132

ООО “Издательство “Триада”. ИД № 06059 от 16.10.01 г.
170034, г. Тверь, пр. Чайковского, д. 9, оф. 514, тел./факс: (4822) 42-90-22, 35-41-30
E-mail: triadatver@yandex.ru; <http://www.triada.tver.ru>

Подписано к печати 18.04.2017 г. Формат 60/84 1/16. Усл. печ. л. 9
Бумага офсетная. Печать офсетная. Гарнитура Times New Roman. Тираж 1000 экз.

Заказ 4044
Отпечатано в ООО “Тверская фабрика печати”.
170006, г. Тверь, Беляковский пер., 46



PRODUCT CATALOGUE

December 2016

New generation of laser physiotherapy devices
"LASMIK" and **"LASMIK-ILBI"**

Upgraded laser therapy devices **"Matrix"**, **"Matrix-ILBI"**, **"Matrix-Urolog"**, **"Matrix-MINI"**, **"Matrix-BIO"**, etc.

High-performance physiotherapy complexes
"Matrix-Urolog" and **"LASMIK-Cosmetolog"**

Lipolytic program and complex **"LASMIK-Slim"**

Vacuum massage device **"Matrix-VM"**

Heads, KIVL disposable sterile light guides for ILBI, additional devices, physiotherapy stand, books, training, etc.



for medicine...

obstetrics and
gynecology
andrology and urology
dermatology
cardiology
neurology
ophthalmology
pediatrics
dentistry
musculoskeletal system
diseases
physiotherapy
etc.

for cosmetology...

general rejuvenation
face-lifting
body shape correction
hair cosmetology
laser peeling
laser phoresis of
hyaluronic acid and
other biologically active
substances
(anti age program,
laser biorevitalization,
lipolytic program,
anti-cellulite program)
dermatological
problems
(vitiligo,
acne,
herpes,
furunculosis, etc.)
etc.

BRAND NEW!

“LASMIK” and “LASMIK-ILBI”



New generation of the devices – new potential for treatment and prevention of a wide range of diseases

- The frequency range has been extended up to 10 000 Hz.
- For the first time pulsed lasers can securely operate at the frequency of 10 000 Hz.
- Convenient, extremely reliable LASMIK® connector with the colour differentiation of the wavelength of lasers.
- Five-year manufacturer's warranty, including the warranty for all pulsed laser emitting heads.

Best design and ergonomics



It is simple and easy to operate the LASMIK devices!

Simple, user-friendly control panel.

It is possible to learn to operate the apparatus in 5 minutes, and it is not necessary to refer to the instruction manual. Everything is extremely simple and clear!

In 95% of techniques the exposure is 2 or 5 minutes, which is taken into account in "LASMIK" devices, – the fixed timer values are set exactly like this. This saves time and makes the work of the medical staff much easier. But it is also possible to set any time from 1 second to 90 minutes.

The frequency of 10 000 Hz allows the implementation of new high-performance laser therapy techniques (dermatology, neurology, anesthesia, etc.). The fixed values are set according to those which are most frequently used in the techniques (10, 80, 3000 and 10 000 Hz), but it is possible to choose different ones from 0,5 to 10 000 Hz.



The built-in photometer allows the user to monitor pulse and average power over the entire spectral range (from 365 to 960 nm).

The most reliable and simple connection with the emitting head.

The power switch is on the rear panel of the device which completely eliminates its accidental shutdown during the procedure and increases the reliability of the operation.

5-year warranty!

1. Only heavy-duty membrane keyboards are used, which ensures **1 000 000** pressings of any button of the keyboard, that means **more than 20 years** of the continuous work of the device!

There can fast occur fading, cracking and button breaking in standard devices. We use sealed electrically conductive contact pads, which are located at some distance; when pressing the membrane with a finger, it flexes till the touch of the contact surfaces and thus the switch-over happens.



2. The extremely reliable connectors TRS 6.35 mm stereo, made in accordance with the unique 3-wire LASMIK® technology are impossible to break!

The time of warranty is no less than 20 years, the process of changing the laser emitting head is simple and easy!

3. Each of the three control lines is duplicated with a double wire which completely eliminates any accidental breakage and greatly increases the reliability of the device as a whole.

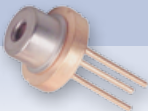
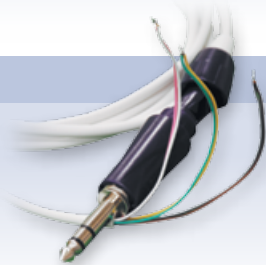

4. Foreign laser diodes from the world's leading manufacturers have a warranty period of the continuous operation up to 150 thousand hours! It is unreasonable to save on reliability.

5. The remote power supply unit certified in accordance with the European standards for medical equipment (EN60601-1) eliminates the high voltage in the device itself and increases its reliability.



Control panels of “Matrix” and “LASMIK” devices have slight functional differences.

Parameters	“Matrix” and “Matrix-Urolog”	“LASMIK” and “LASMIK-ILBI”
Laser illumination pulse repetition rate, Hz:		
• Fixed	10, 80, 600, 3000	10, 80, 3000, 10 000
• Optional	0,5–3000	0,5–10 000
Time of the illumination exposure of the device, min.:		
• Fixed	1; 10 and “H”	2; 5 and “H”
• Optional	0,1–90	0,1–90
• External modulation mode	Availability	Availability

The main advantages of “LASMIK” and “LASMIK-ILBI” devices

- The frequency range has been extended up to 10 000 Hz.
- The availability of the option with the vacuum channel for laser-vacuum technique (“LASMIK”).
- The power control and the possibility to set up the frequency from 0,5 up to 10 000 Hz in each of the channels.
- For the first time pulsed lasers can operate at the frequency of 10 000 Hz.
- The wavelength and power limit indication on all laser heads.
- The measurement and digital indication of the pulse and average illumination power within the range of wavelengths from 365 to 960 nm.
- The continuous, pulse, modulated, multi-frequency and bioresonance operation mode of laser emitting heads is ensured.
- The fixed timer values of 2 and 5 min allow quick and unmistakable choosing of the required mode, which is used in most laser therapy techniques.
- The maximum choice of laser emitting heads for all laser therapy techniques.
- Convenient and extremely reliable LASMIK® connectors for the attachment of the heads, which are of different colours according to the wavelength of the laser used.
- The coloured fastening straps of laser emitting heads for ILBI together with the colour differentiation of the connectors allow avoiding mistakes while choosing the wavelength required for the procedure.
- The devices for ILBI are unified with general therapy devices, all laser therapy techniques can be implemented on all devices.
- The devices are maximally unified to be combined with other physiotherapy devices and to implement conjoined and combined techniques.
- The minimum weight allows moving the devices to any department of the medical center.
- The protection against any unauthorized change of the operation mode during the procedure.
- Modern design and increased reliability.
- 5-year device warranty and for the first time the warranty for IR-laser emitting heads.

Specifications of “LASMIK” and “LASMIK-ILBI” devices

The number of concurrent channels for emitting heads	1, 2 or 4
Control and indication of the illumination power and wavelength of the laser sources	There is
The illumination wavelength for laser emitting heads, nm	365–1300 (is defined by the type of the exchangeable remote emitter)
The illumination wavelength for EHF range, mm	4,9; 5,6; 7,1 (is defined by the type of the exchangeable remote emitter)
The method of setting of the timer value and pulse repetition frequency	fixed or optional
The timer (automatic mode)	
fixed values, min	2; 5 and “N” (not limited)
optional choice, min	0,1–90
The frequency of the modulation and repetition of the pulses, Hz	
fixed values	10, 80, 3000, 10 000
optional choice	0,5–10 000
The illumination power adjustment	from 0 to maximum value
Weight, g	
LASMIK-01 (2 laser channels)	800
LASMIK-02 (4 laser channels)	4200
LASMIK-03 (1 laser and vacuum channel)	950
Dimensions, mm:	
LASMIK-01 (2 laser channels)	280×210×105
LASMIK-02 (4 laser channels)	345×260×150
LASMIK-03 (1 laser and vacuum channel)	280×210×105
Electrical safety class	II, B type (grounding is not required)
Laser safety class	1M
Power:	
Voltage, V	90–250
Frequency, Hz	47–65
Maximum power consumption, VA	
LASMIK-01 (2 laser channels)	10
LASMIK-02 (4 laser channels)	15
LASMIK-03 (1 laser and vacuum channel)	12
The average operation period without maintenance service, h	5000
The warranty*	5 years

* For the base unit and IR-pulsed laser emitting heads, 12 months for the rest products.



The Comparison of the Parameters



of the laser emitting heads for the devices of new and previous generation

The devices of new generation of LASMİK® ("LASMİK", "Agiur", "LASMİK-ILBI", "LASMİK-BIO", etc.) technology			The devices of previous generation ("Matrix", "Matrix-Urolog", "Mustang-2000", etc.)		
Head name	Parameters		Head name	Parameters	
	Wave-length, nm	Power		Wave-length, nm	Power
ML01H (ML-904-80)	904	50 W (matrix)	ML01H	890-904	50 W (matrix)
ML01HM (ML-904-200)	904	200 W (matrix)	-	-	-
ML01HP (ML-635-40)	635	35 W (matrix)	ML01HR	650-670	35 W (matrix)
ML-650-100	650	100 mW (matrix)	-	-	-
LO-890-10 (LO-904-10)	904	10 W	LO1	890-904	5 W
LO-890-15 (LO-904-15)	904	15 W	LO2	890-904	10 W
LO-890-20 (LO-904-20)	904	20 W	LO3	890-904	15 W
LO-890-25 (LO-904-25)	904	25 W	LO4	890-904	20 W
LO-890-100 (LO-904-100)	904	100 W	LO7	890-904	90 W
LOH2 (LO-635-5)	635	5 W	LOH2	650-670	5 W
KLO-405-120	405	120 mW	KLO-405-120	405	120 mW
KLO-450-50 (KLO-445-50)	445-450	50 mW	-	-	-
KLO-530-50 (KLO-525-50)	520-530	50 mW	-	-	-
KLO-635-5	635	5 mW	KLO1	635	5 mW
KLO-635-15	635	15 mW	KLO3	635	10 mW
KLO-635-40	635	40 mW	KLO4	635	40 mW
KLO-635-50 (NLBI)	635	50 mW	-	-	-
KLO-650-50	650	50 mW	KLO2	650	40 mW
KLO-650-200	650	200 mW	-	-	-
KLO-780-90	780-785	90 mW	KLO-780-90	780-785	90 mW
KLO-808-200	808	200 mW	KLO6	808	200 mW
KLO7	1300	5 mW	KLO7	1300	5 mW
KL-ILBI-365-2 (for UVBI)	365-400	1,5-2 mW*	KL-ILBI-365	365-400	1,5-2 mW*
KL-ILBI-405-2	405	1,5-2 mW*	KL-ILBI-405	405	1,5-2 mW*
KL-ILBI-450-2 (KL-ILBI-445-2)	445-450	2 mW*	-	-	-
KL-ILBI-450-20 (KL-ILBI-445-20)	445-450	20 mW*	-	-	-
KL-ILBI-530-2 (KL-ILBI-525-2)	520-530	2 mW*	-	-	-
KL-ILBI-530-20 (KL-ILBI-525-20)	520-530	20 mW*	-	-	-
KL-ILBI-635-2	635	2 mW*	KL-ILBI	635	2 mW*
KL-ILBI-635-20	635	20 mW*	KL-ILBI-M	635	20 mW*
KL-ILBI-808-40	808	40 mW*	KL-ILBI-IR	808	40 mW*

* At the output of the light guide KIVL-01 produced by the Research Center "Matrix" under TR 9444-005-72085060-2008.



With one laser

on the left

The heads are used for the external exposure through the local contact with the mirror nozzle, distant or contact without a nozzle, and with optic and magnetic nozzles. The heads are made in accordance with brand new technologies from special heavy-duty plastic, do not break, crack or crash – they are more reliable than those made from metal.

Designation: TYPE (LO – pulsed, KLO – continuous) – wavelength – power.

For example, LO-904-20 – pulsed laser emitting head with the wavelength of 904 nm (IR) and maximum power of not less than 20 W (can be adjusted downwards).

Matrix

in the middle

Designation: TYPE (ML) – wavelength – power.

Matrix emitting heads with 8 pulsed laser diodes of IR (904 nm) or red spectrum are most often used. Detailed information is given further.

For intravenous laser blood illumination (ILBI)

on the right

Designation: KL-ILBI – wavelength – power.

Detailed information is described below.

All laser emitting heads are attached to the device with the help of convenient, modern and extremely reliable LASMIK® connectors specially designed for laser therapy devices.



Matrix laser emitting heads



These are necessary for the optimization of the impact area and the energy density of the impact, laser diodes are located on the surface so that the light fields created by them separately when combining ensure the best spatial-energy parameters of the technique as a whole [Moskvin S.V., 2008, 2014].

Such heads have maximum versatility and can be implemented practically in all the laser therapy techniques, except acupuncture, that is why they are included in the simple kits of the equipment. They are used for the external application as well as for the impact on the projection of the internal organs, located at the depth up to 15 cm (IR-lasers).

Parameters	ML-904-80 (ML01K)	ML-904-200 (ML01KM)	ML-635-40 (ML01KR)
Wavelength, nm	904	904	635
Spectrum (colour)	IR	IR	red
Number of laser diodes, pcs.	8	8	8
Pulse power, W	80	200	40
Impact area, cm ²	8–50	8–50	8–50
Available analogues	Conditionally	No	No

Laser diodes in the modern matrix laser heads ML-904-80, ML-904-200 and ML-63540 are made under the LASMİK® technology, and are located right on the surface, not behind any glass (no distance), which can significantly improve the efficiency of impact efficiency with a lower number of laser sessions. The square of the light spot, according to which the power density is calculated, at the distance up to 0,5 cm from the LD is 8 cm², that is 8 light sources can be presented with the sum of 8 laser heads with one laser and mirror nozzle. At the distance of 7 cm (limit) a pretty much rectangular area with the size of 5×10 cm is formed and the power density is calculated taking into consideration the aggregate capacity of all the laser diodes on the square of 50 cm².

The laser emitting head ML-635-40 (ML01KR) is mostly used for the technique of non-invasive (external, transdermal) laser blood illumination with the unique efficiency and for the illumination of the pathological focuses at the depth of up to 5 cm.

The laser emitting head LO-LLNP contains 4 separate blocks with 3 continuous red and 2 pulsed IR LDs, so, in this case the matrix emitter is not flat, but volumetric. The boards are on the flask opposite each other, as a result, all sides of a penis are equally illuminated.

Matrix emitting heads with continuous laser diodes are rarely used.

Laser emitting heads for intravenous laser blood illumination (ILBI)



Name	Wavelength, nm	Power*, mW
Laser emitting head KL-ILBI-365-2 (for UVBI)	365–400	2
Laser emitting head KL-ILBI-405-2	405	2
Laser emitting head KL-ILBI-450-2 (KL-ILBI-445-2)	445–450	2
Laser emitting head KL-ILBI-450-20 (KL-ILBI-445-20)	445–450	20
Laser emitting head KL-ILBI-530-2 (KL-ILBI-525-2)	520–530	2
Laser emitting head KL-ILBI-530-20 (KL-ILBI-525-20)	520–530	20
Laser emitting head KL-ILBI-635-2	635	2
Laser emitting head KL-ILBI-635-20	635	20
Laser emitting head KL-ILBI-808-40	808	40

* At the output of the light guide KIVL-01 produced by the Research Center "Matrix".

- **Only lasers for the laser blood illumination!** (No cheap and inefficient LEDs or outdated lamps are used!)
- **Laser light energy is better brought into the light guide** (the greater the power, the better the effect).
- **The convenient housing** (allows easy inserting and removing of the light guide).
- **Has a special laser illuminator** (it does not have contact with the patient and does not cause negative feelings).
- **Optimal dimensions** allow using shorter light guides (to 20 cm) while keeping polarization of light.
- **A special reliable and durable strap** (can be disinfected and sterilized).
- **Straps and connectors match the colour (wavelength) of the laser source** (to avoid mistakes while choosing the head during the procedure).



Heads for non-invasive (external) laser blood illumination (NLBI)



Our studies (1997–2014) have proven that the best option for non-invasive (external) laser blood illumination (NLBI) is the application of the matrix emitting head MLO1KR (ML-635-40) on the projection of large blood vessels close to an injured area, in which pulsed lasers in the red spectrum (635nm) are used [Moskvin S.V., 2014; Moskvin S.V. et al., 2007].

Nevertheless, some specialists prefer to illuminate exactly the projection of the cubital vein, the area through which ILBI is most often implemented. In this case it is necessary to have a special emitting head with much more power as the laser light energy is ten times weakened under such method of delivery.



KLO-635-50 (NLBI)

Basic features

- Laser wavelength – 635 nm (red spectrum).
- Average power – 50 mW.
- Fastened with a special strap on the arm or on the knee above the projection of the vessels.
- A special appliance for power density optimization and stabilization.

Laser-LED matrix emitting head MLS-1 (Effect)



This head is more often used for the systematic exposure on the body, for external laser illumination technique or colour therapy.

Basic features

- The availability of several light sources with a different wavelength (colour).
- The total area of the light spot at the distance of 1 cm – to 40 cm².
- The possibility of the modulation of the LED illumination of any frequency, set on the base unit.
- The possibility of LED or laser switching when all the other light sources are disconnected.
- The use of pulsed lasers of infrared (IR) or red spectrum.

The parameters of the light sources of the emitting head MLS-1 (Effect)

Colour	Wavelength, nm	Type	Number, pcs.	Illumination mode	Total illumination power
Blue	470	LED	12	cont./mod.	20 mW*
Green	530	LED	3	cont./mod.	10 mW*
IR	850–960	LED	4	cont./mod.	60 mW*
Red	635	Laser	3	Pulsed	15 W**
IR	904	Laser	1	Pulsed	10 W**

* For the continuous illumination mode, for the modulated mode the average power is two times decreased.

** Pulse power.

Name	Wave-length, nm	Connector (colour)
Matrix laser emitting head ML01K (ML-904-80)	904	
Matrix laser emitting head ML01KM (ML-904-200)	904	
Laser emitting head LO-890-10 (LO-904-10)	904	
Laser emitting head LO-890-15 (LO-904-15)	904	
Laser emitting head LO-890-20 (LO-904-20)	904	
Laser emitting head LO-890-25 (LO-904-25)	904	
Laser emitting head LO-890-100 (LO-904-100)	904	
Laser emitting head KLO-780-90	780–785	
Laser emitting head KLO-808-200	808	
Laser emitting head KLO7	1300	
Laser emitting head KL-ILBI-808-40	808	
Laser emitting head KLO-405-120	405	
Laser emitting head KL-ILBI-405-2	405	
Laser emitting head KL-ILBI-365-2 (for UVBI)	365–400	
Matrix laser emitting head ML01KR (ML-635-40)	635	
Laser emitting head LOK2 (LO-635-5)	635	
Laser emitting head KLO-635-5	635	
Laser emitting head KLO-635-15	635	
Laser emitting head KLO-635-40	635	
Laser emitting head KLO-635-50 (NLBI)	650	
Laser emitting head KLO-650-50	650	
Laser emitting head KLO-650-200	650	
Laser emitting head KL-ILBI-635-2	635	
Laser emitting head KL-ILBI-635-20	635	
Laser emitting head KLO-450-50 (KLO-445-50)	445–450	
Laser emitting head KL-ILBI-450-2 (KL-ILBI-445-2)	445–450	
Laser emitting head KL-ILBI-450-20 (KL-ILBI-445-20)	445–450	
Laser emitting head KLO-530-50 (KLO-525-50)	520–530	
Laser emitting head KLO-530-50 (KLO-525-50)	520–530	
Laser emitting head KL-ILBI-530-20 (KL-ILBI-525-20)	520–530	

The development of laser physiotherapy requires several devices to be implemented in a conjoined and combined procedure in one workplace. The techniques of laser-vacuum massage, EHF-laser therapy, vibromagnetic laser massage, local laser negative pressure (LLNP), laser biorevitalisation have been actively developing, and recently are gaining more and more popularity. For their successful implementation it is necessary to have different devices, nozzles, gels, etc. at hand. A new specialized equipment stand has been designed for physiotherapy rooms in medical institutions and cosmetology centres (salons).

Special holders are designed for the emitting heads and nozzles for laser and physical therapy devices “Matrix”, “LASMIK”, “Agiur”, “Matrix-ILBI”, “Matrix-Urolog”, “Matrix-VM”, etc.

The characteristics of the equipment stand LASMIK-SF

- It allows the setting of several different devices (laser, vacuum, BIO, etc.) in one place and combining (conjoining) different types of physiotherapy exposure.
- It is convenient and ergonomical.
- Methodical references and records are always at hand.
- There are several shelves for nozzles, accessories and storage of the supplies.
- There are specific holders for 5 laser emitting heads.
- Castors make the stand easy to move around the medical centre.



BRAND NEW!

The holder is designed to clasp the emitting heads at the place of the illumination or to keep (fix) them between procedures, there are two options available: Dr-1 and Dr-2.

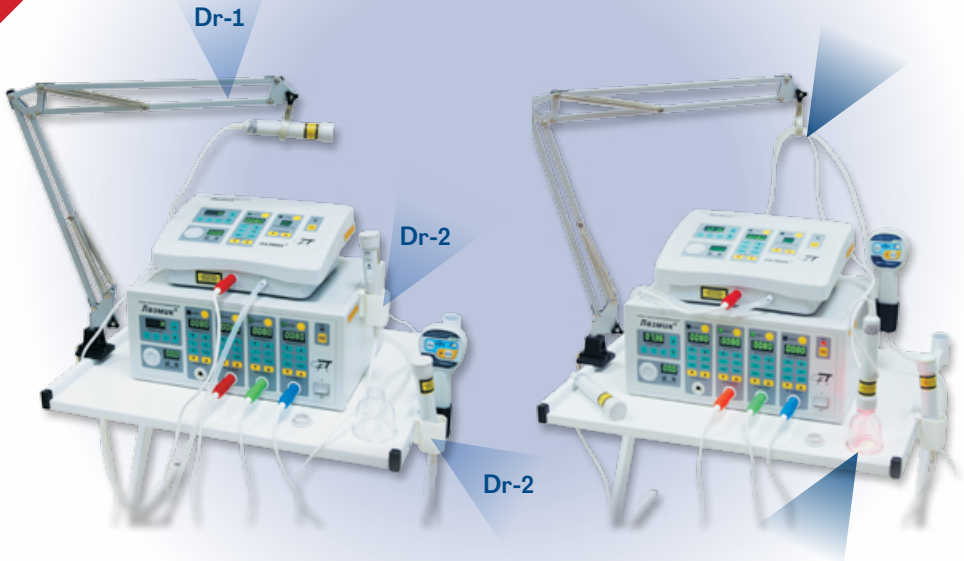

Holder Dr-1 is designed to arrange an emitting head on the place of the implied exposure, for this purpose it is fixed in a special ring (the photo on the left at the top), it is also used for the vertical fixation of the power cord of an emitting head and a vacuum tube (the photo on the right with the arrow up) while implementing laser-vacuum massage procedures (the photo on the right the arrow down). Illumination from above eliminates patients' unpleasant feelings caused by the cord and tube slipping on the body and increases the reliability of the operation of the laser-vacuum apparatus.

Holder Dr-2 is fixed to the metal surface of the 4-channel option of "Matrix", "LASMIK" and "Matrix-Urolog" devices or to the side surface of the stand with the magnetic lock, it is designed to fix (keep) the emitting heads between procedures, for this purpose they are located in the holder cavity.

You should not direct a laser emitting head to the eyes or to the glare surfaces of the surrounding things with the help of the Dr-1. It is necessary to shut the emitting heads with a special protective cover while fixing (keeping) them in Dr-2.

Special emitting heads



BRAND NEW!



The IR (wavelength – 904 nm) pulsed laser emitting head of the increased power (up to 300 W) ML01KM is designed to treat diseases such as gout, psoriasis, prostate adenoma, etc.

We continue producing matrix LED heads for all the devices of “Matrix” and “LASMIK” series. They are much less efficient than laser light sources, but are used in some techniques for psycho- and colour therapy.

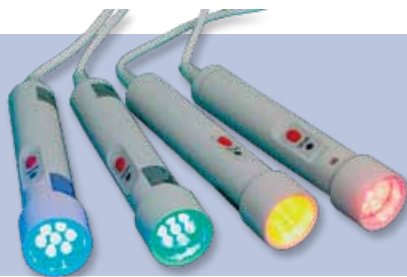

The emitting heads of EHF-range can be connected to all devices of “Matrix” series. The conjunction and combination of different physical healing factors make it possible to increase efficiency of the treatment.

A special acupuncture nozzle (concentrator) is used to implement EHF-acupuncture.



The advantages of individual flasks for the local laser negative pressure (LLNP) technique or for the laser-vacuum massage

1. A patient's complete safety is ensured with the use of the individual flasks.
2. Patients are more willing to undergo the procedure having been informed about such a possibility.
3. The use of the individual flasks is an additional income for the medical centre.



New vacuum cup attachments for laser-vacuum massage (KB-5) – now 7 pieces!

The nozzles for the operation on a face – FVM-25 and FVM-15, diameter of 25 and 15 mm correspondingly, are additionally supplied.

Most patients prefer procedures implemented with the help of individual nozzles (cups), that is why there is a possibility to buy nozzles with a discount.



Slot nozzle FVM-S

Light guides KIVL-01 for the intravenous laser blood illumination (ILBI)

The peculiarities of the sterile light guides KIVL-01 of the Research Centre “Matrix” produced in accordance with TR 9444-005-72085060-2008:

- super-sharp injection needles are painless and ensure patients' maximum comfort;
- the light guide with the diameter of 500 μm ensures stable exposure parameters while preserving the initial illumination polarization and maximum therapeutic effect;
- the high ratio of the input of the laser light into the fiber ensures high and stable power at the light guide output;
- does not damage the laser diode in the emitting head.

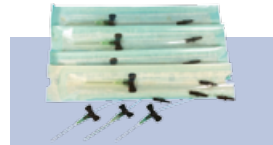

ATTENTION! Only light guides KIVL-01 produced in accordance with TR 9444-005-72085060-2008 can be used with “Matrix” and “LASMIK” devices! Other light guides cannot ensure the stable illumination power and positive results of the treatment, and can cause emitting head failure.

A disposable filtration system F-1 for the vacuum therapy devices “Matrix-VM” or laser-vacuum therapy “LASMIK-03”

The filter is designed to protect the device from the penetration of foreign substances (oil, lotion, saliva etc.) inside the pump. The filter works within the period of 7 to 30 days, depending on the intensity and operating conditions, that is why it is recommended to change the filter weekly. Late filter replacement can cause the device to fail, and the necessity to repair it (which is expensive).



Laser physiotherapy device LASMIK®



This is the only medical device which has 8 wavelengths for laser cosmetology and medicine – 405, 445, 525, 635, 785, 808, 904, 1300 nm.

The laser emitting head KLO-780-90 (780–785 nm, 90 mW) and cosmetology transparent attachment LASMIK® is designed to implement laser phoresis (biorevitalization according to LASMIK® technology).

Now the set of vacuum cups attachments for the vacuum and laser-vacuum massage KB-5 contains special nozzles for the face FVM-25 and FVM-15 with the diameter of 25 and 15 mm. Special shockproof material on the basis of polycarbonate is used for the production of the nozzles. The nozzles cannot be broken or scratched, they are easy to wash and sterilize. Optimum geometric dimensions allow achieving the maximum technique effect.



Special apparatus gels and masks:
LASMIK® hyaluronic acid gel;
LASMIK® anti-cellulite gel;
LASMIK® revitalizing mask.

New formula – better quality!

Prices are now lower, and there are discounts available to regular customers.

Optic and magnetic attachments

These attachments allow the implementation of laser illumination with a pathological focus. This results in minimal loss, and with the required shape and field area, allow the implementation of magnetic laser therapy.

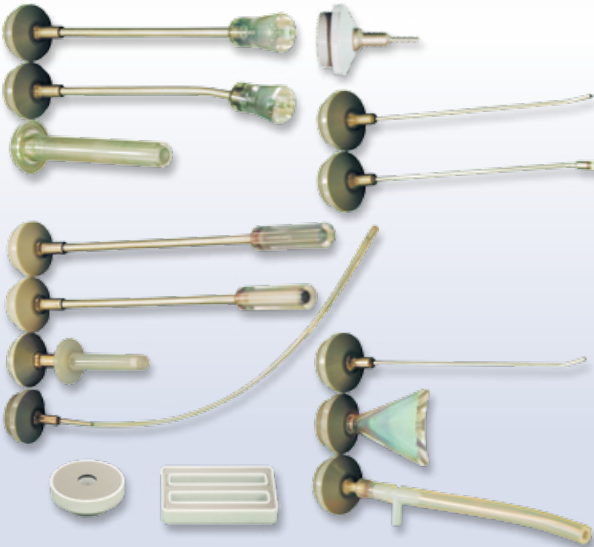

External modulation unit “Matrix-BIO”

It can operate with all the devices, and increases the efficiency of laser therapy through the synchronization of the exposure with a patient’s biorhythms.

Protective glasses

The glasses are used to protect the medical staff from the reflected illumination during the procedure; the glasses are of modern design, light and comfortable.

Proctology nozzles

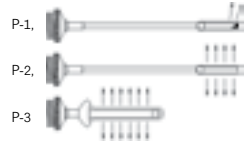

Gynecology nozzles

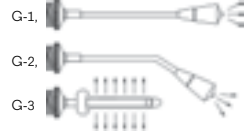

U-1 Urology nozzle for the heads of LO type



The set of otolaryngology nozzles: a – L-1-1 (S-1-1); b – L-1-2; c – adapter

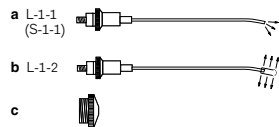

The set of stomatology nozzles: a – S-1-1, b – S-1-2, c – adapter

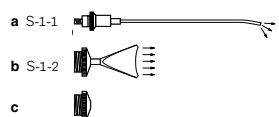

A disposable light guide with a needle for ILBI

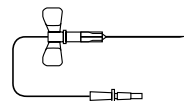

A mirror magnet nozzle attachment ZM-50 for the heads of LO and KLO type



Mirror magnet nozzle attachment MM-50

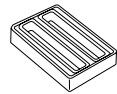

Mirror nozzle attachments



Acupuncture nozzle attachment A-3



“Matrix-ILBI” laser therapy device (upgraded)



BRAND NEW!



Digital indication of the laser illumination wavelength.

The connector under TRS standard 6.35 mm stereo (LASMNIK®), the colour of the connectors and fastening straps of the KL-ILBI heads corresponds with the laser illumination wavelength. This helps to avoid mistakes during procedures and the use of all types of laser emitting heads for ILBI.

The operation with pulsed laser emitting heads is allowed. Now it is possible to carry out not only intravenous laser blood illumination procedures (ILBI) with the help of specialized disposable sterile light guides with KIVL-01 needle under TR 9444-005-72085060-2008, but also other laser therapy techniques: external illumination, non-invasive (transdermal) laser blood illumination (NLBI), acupuncture, projection on to the internal organs, para-verbal, intracavitary illumination, etc.

Name	Wavelength, nm	Spectral range	Illumination power at the output of the light guide KIVL-01 TR 9444-005-72085060-2008, mW
KL-ILBI-365-2 (for UVBI)	365	UV	2 mW
KL-ILBI-405-2	405	UV	2 mW
KL-ILBI-445-2	445–450	Blue	2 mW
KL-ILBI-450-20	445–450	Blue	20 mW
KL-ILBI-525-2	520–525	Green	2 mW
KL-ILBI-525-20	520–525	Green	20 mW
KL-ILBI-635-2	635	Red	2 mW
KL-ILBI-635-20	635	Red	20 mW
KL-ILBI-808-40	808	IR	40 mW



“Matrix-Urolog” device (apparatus) is made under the block principle [Moskvin S.V., 1993–2003], according to which the complex is most often located on the stand LASMIK-SF, it consists of three parts: base unit, emitting heads and nozzles (magnetic and optical).

Name of the equipment recommended in the set	Number, pcs.
ALT “Matrix-Urolog” (3-channel specialized base unit)	1
Vibromagnetic laser head VMLH10 to cure prostatitis	1
Laser emitting head LO-904-20 (pulsed IR, 890–904 nm, 15–20 W)	2
Laser emitting head KLO-635-15 (continuous red, 635 nm, 15 mW)	1
Laser emitting head ML-904-80 (pulsed IR, 890–904 nm, matrix)	1
Attachments/nozzles (set): P-1, P-2, P-3, U-1, ZN-35 (2 pcs.), MM-50, ZM-50	1
The book: Laser therapy in urology. – M., 2009. – 132 p.	1
“Matrix-VM” vacuum massage apparatus	1
The laser emitting head LO-LLNP to cure the patients with erectile dysfunction and prostatitis (matrix, 12 continuous lasers of 635 nm, power ≥ 60 mW and 10 IR lasers, pulsed, ≥ 70 W). Made under new technology, operates up to the frequency of 10 000 Hz, TRS 6.35 mm stereo connectors.	1
The flask for the local laser negative pressure technique B-LLNP (3)	2

The emitting heads and nozzles of “Matrix-Urolog” complex

It is possible to expand the set with different emitting head and nozzles, which will allow for a more efficient treatment together with the use of the base emitting heads recommended for “Matrix-Urolog” laser therapy device.

Vibromagnetic laser head VMLG10

The unique vibromagnetic laser head of VMLG10 complex, which is used to cure the patients with prostatitis, is a rectal attachment with a ring magnet with the induction of 25 mT and a laser illumination diffuser (wavelength of 635 nm, power of 10 mW).

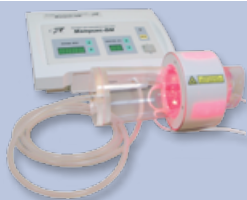

“Matrix-LLNP” complex

It is possible to include the set for the treatment of the patients with erectile dysfunction with the help of local laser negative pressure technique into “Matrix-Urolog” complex. “Matrix-LLNP” complex contains:

- “Matrix-VM” or “LASMIK-03” vacuum massage apparatus;
- the laser emitting head LO-LLNP;
- special flasks B-LLNP (2 pcs.).

ATTENTION! The lasers of red and IR spectrum are precisely used in LO-LLNP emitting head while ineffective cheap light diodes are used in “analogues”. Moreover, laser illumination of the red and the infrared spectrum is alternated in accordance with the biological rhythms, which ensures a more adequate response of important regulatory, vascular and immune systems.

“LASMIK-Cosmetolog” complex

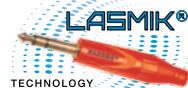

This unique medical device has eight wavelengths for laser cosmetology and medicine – 405, 445, 525, 635, 785, 808, 904, 1300 nm and the most comprehensive set of special nozzles.

The low price of the basic kit allows for the significantly expanding number of potential clients!

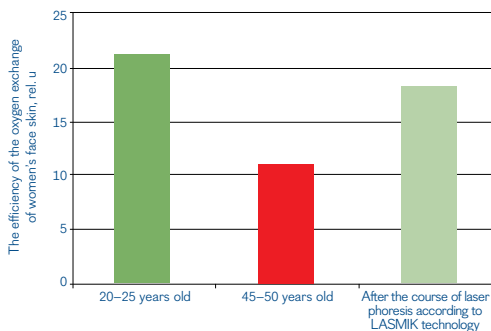

The effects of laser biorevitalization under LASMIK® technology are scientifically substantiated!

The results of the research conducted have proved that the efficiency of the oxygen exchange of skin cells, which decreases dramatically with age, can recover up to the particular to people who are 20–25 years younger. The lipofuscin content is decreased and the structure of collagen and elastin is improved.

Laser emitting heads KLO-780-90 (wavelength of 780–785 nm) and KLO-405-120 (wavelength of 405 nm) with a cosmetology nozzle for the laser biorevitalization and hyaluronoplasty techniques.

LASMIK® gel with hyaluronic acid

LASMIK® anti-cellulite gel

LASMIK® revitalizing mask

Glasses for eye protection from laser illumination during face procedure

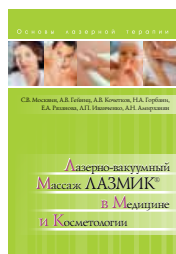

The unique training and methodological support, master classes, specialization in laser medicine, field training, individual training, books, training videos, etc.

LASMIK-Slim is a unique body shape corrector and weight loss program which gives patients the opportunity to not only improve their body shape and skin properties, but also to lose weight and keep it off for a long time without any diets or excessive physical activity. It is based on physiotherapy procedures, the exposure is implemented with the low-intensity (low-energy, “cold”) lasers, that is why the tissue is not heated up, the fat is not “melted” or “burned”, but rather, optimal conditions for its release from adipocytes with further disposal have been created.

The exposure with the low-intensity (“cold”) laser is implemented with the aim to release fats from adipocytes (to reduce fat deposits) with the simultaneous activation of the system of circulation and the metabolising of fatty acids, correction of the energy regulation within the physiological norm.

The LASMIK-Slim program is not only designed to create a slimmer body, but is also the solution to people carrying extra weight as a whole. As a result of the physiotherapy procedures and a patient’s implementation of some simple recommendations the shift of the whole complex of the energy balance and the process of metabolism regulation occurs, the transition to the condition under which any spontaneous excess accumulation of fats is not allowed for a long time (up to 6–12 months) is achieved.

Laser physiotherapy complex for LASMIK-Slim program of the body shape correction:



1. **“Matrix-4k”** laser therapy device – 1 pc.
2. **“LASMIK-03”** laser therapy device – 1 pc.
3. Special laser emitting heads – 6 pcs.
 - Laser emitting head **KLO-635-5** – 1 pc.
 - Laser matrix emitting heads **ML-635-40** – 1 pc.
 - Laser emitting head **KLO-650-50-1** – 2 pcs.
 - Laser emitting head **KLO-650-50-4** – 2 pcs.
4. Cosmetology nozzles – 15 pcs.
5. Emitting head clamps on the body of a patient – 1 set.
6. **LASMIK-SF** stand with the emitting head holders – 1 pc.
7. The guidelines and individual training.



Title

Moskvina S.V., Achilov A.A. Basics of laser therapy. – M., 2008. – 256 p.

Series: Experimental magnetobiology. – M.–Tver–Tula, 2006–2007 (for 1 book).

Nasedkin A.A., Moskvina S.V. Laser therapy of patients with heroin addiction. – M., 2004. – 48 p.

Ivanchenko L.P., Kozdoba A.S., Moskvina S.V. Laser therapy in urology. – M., 2009. – 132 p.

Moskvina S.V., Kupeev V.G. Laser chromo- and colourtherapy. – M., 2007. – 95 p.

Baybekov I.M. et al. Normal erythrocytes, pathologies and under laser exposure. – M., 2008. – 256 p.

Moskvina S.V., Nasedkin A.N., Osin A.Y., Khan M.A. Laser therapy in pediatrics. – M., 2009. – 480 p.

Fedorova T.A., Moskvina S.V., Apolikhina I.A. Laser therapy in obstetrics and gynecology. – M., 2009. – 350 p. – M., 2009. – 350 p.

Geynits A.V., Moskvina S.V. Laser therapy in cosmetology and dermatology. – M., 2010. – 400 p.

Babushkina G.V., Moskvina S.V. Laser therapy in the complex therapy of the patients with arterial hypertension. – M., 2013.

Ryazanova E.A., Moskvina S.V. Laser therapy of alopecia. – M., 2010. – 72 p.

Moskvina S.V., Amirkhanyan A.N. Combined and conjoined laser therapy techniques in dentistry. – 2011. – 208 p.

Nasedkin A.N., Moskvina S.V. Laser therapy in otorhinolaryngology. – M., 2011. – 208 p.

Geynits A.V., Moskvina S.V., Achilov A.A. Intravenous laser blood illumination. – M., 2012. – 336 p.

Kochetkova A.V., Moskvina S.V., Karneev A.N. Laser therapy in neurology. – M., 2012. – 360 p.

Moskvina S.V. et al. Laser phoresis, laser biorevitalization, LASMNIK® lipolytic and anticellulite programs. – 2012. – 120 p.

Collected articles on laser physiotherapy in cosmetology. – M., 2012. – 40 p.

Moskvina S.V., Ponomarenko G.N. Laser therapy with “Matrix” and “LASMNIK” series devices. – 2015. – 208 p.

Laser-vacuum massage in rehabilitation and sports medicine // Guidance manual. – M., 2012. – 28 p.

Laser phoresis in rehabilitation and sports medicine // Guidance manual. – M., 2012. – 22 p.

Flash-card with the lectures of Moskvina S.V., articles on laser medicine and cosmetology, books, etc.

Uts S.R., Shnider D.A., Moskvina S.V. et al. Collection of legal documents on laser medicine. – 2014. – 212 p.

Moskvina S.V. et al. LASMNIK® laser-vacuum massage in medicine and cosmetology. – M., 2014. – 150 p.

Moskvina S.V. Laser therapy efficiency. Series “Effective laser therapy”. – M., 2014. – Vol. 2. – 896 p.

Laser therapy of patients with osteoarthritis // Guidance manual. – M. 2015. – 32 p.

Laser therapy in treatment and rehabilitation, and preventive programs: clinical guidelines (Official document). – M., 2015. – 80 p.

The organization of training for the medical staff with higher and secondary education, short-term professional development on the program “Laser medicine”



Research Center «Matrix» designs and produces physiotherapy equipment, carries out scientific research and does everything to implement the most efficient techniques. Dozens of patients, scientific articles, guidelines, books, theses, etc. prove the leadership of the centre in this field of medicine and cosmetology.

Laser therapy devices of the “Matrix” and “LASMIK” series are the most versatile. Laser physiotherapy complex does not have any analogues and is successfully used by specialists for the treatment of prostatitis, erectile dysfunction, etc. “Matrix-Cosmetolog” and “LASMIK” have been used for many

years by cosmetologists and dermatologists in their practice, these are the only devices for laser biorevitalization, which are registered in Russia as medical devices. “Matrix-ILBI” device allows implementation of intravenous laser blood illumination with red and ultraviolet spectrum (ILBI+LUVBI technique). Our center is the only one which produces the laser emitting head KL-ILBI-365 for LUVBI. Long-term clinical studies carried out together with the leading medical centers proved the unprecedented high efficiency of the method. Scientific developments of the center ensure the professionals’ successful work. We do not stop there, doctors collaborating with us can take part in conferences and seminars, can constantly get consultations on the most efficient latest therapy techniques and books from new “Effective laser therapy” series.

The scientific supervisor is **Sergey V. Moskvina**, Doctor in Biology, Candidate of Engineering Sciences, leading researcher of the State Research Center of Laser Medicine FMBA of Russia, Professor at the Department of Rehabilitation Medicine of the Institute of Professional Development FMBA of Russia, Professor of Samara Medical Institute “REAVIZ”. He is the author of more than 30 patents for invention and 500 scientific studies, including 50 monographs mainly in the sphere of the research of the mechanisms of biological effect of low-intensity laser illumination and clinical application of laser therapy (in co-authorship with the leading specialists in different fields of medicine). The email address to contact for any advice on laser therapy application: 7652612@mail.ru

International FaranTech Co.

Address: Iran, Tehran, West of Niayesh Highway, First Shahransq.
West Somaye Str. No. 1, Negin Building,
4th floor, Unit 401

Tel.: +98 21 44 31 63 31

E-mail: info@farantech.co

Website: www.lasmik.ir

LAZMIK Australia Pty Ltd.

Postal address: 86 Meander Valley Road,
Westbury, Tasmania, Australia, 7303

E-mail: lazmik.australia@gmail.com

Website: www.lazmik.com.au



**There is a one step
from science
to practice –
take this step
with us!**

Laser
Therapy
Devices

LASMIK®



**For Highly Effective
Low Level
Laser Therapy!**

